

Evaluation of the Flashing Yellow Arrow Permissive-Only Left-Turn Indication Field Implementation

DETAILS

0 pages | null | PAPERBACK

ISBN 978-0-309-42938-2 | DOI 10.17226/23111

AUTHORS

BUY THIS BOOK

FIND RELATED TITLES

Visit the National Academies Press at NAP.edu and login or register to get:

- Access to free PDF downloads of thousands of scientific reports
- 10% off the price of print titles
- Email or social media notifications of new titles related to your interests
- Special offers and discounts



Distribution, posting, or copying of this PDF is strictly prohibited without written permission of the National Academies Press. (Request Permission) Unless otherwise indicated, all materials in this PDF are copyrighted by the National Academy of Sciences.

ACKNOWLEDGMENT

This work was sponsored by the American Association of State Highway and Transportation Officials (AASHTO), in cooperation with the Federal Highway Administration, and was conducted in the National Cooperative Highway Research Program (NCHRP), which is administered by the Transportation Research Board (TRB) of the National Academies.

COPYRIGHT PERMISSION

Authors herein are responsible for the authenticity of their materials and for obtaining written permissions from publishers or persons who own the copyright to any previously published or copyrighted material used herein.

Cooperative Research Programs (CRP) grants permission to reproduce material in this publication for classroom and not-for-profit purposes. Permission is given with the understanding that none of the material will be used to imply TRB, AASHTO, FAA, FHWA, FMCSA, FTA, Transit Development Corporation, or AOC endorsement of a particular product, method, or practice. It is expected that those reproducing the material in this document for educational and not-for-profit uses will give appropriate acknowledgment of the source of any reprinted or reproduced material. For other uses of the material, request permission from CRP.

DISCLAIMER

The opinion and conclusions expressed or implied in the report are those of the research agency. They are not necessarily those of the TRB, the National Research Council, AASHTO, or the U.S. Government.

This report has not been edited by TRB.

THE NATIONAL ACADEMIES

Advisers to the Nation on Science, Engineering, and Medicine

The **National Academy of Sciences** is a private, nonprofit, self-perpetuating society of distinguished scholars engaged in scientific and engineering research, dedicated to the furtherance of science and technology and to their use for the general welfare. On the authority of the charter granted to it by the Congress in 1863, the Academy has a mandate that requires it to advise the federal government on scientific and technical matters. Dr. Ralph J. Cicerone is president of the National Academy of Sciences.

The **National Academy of Engineering** was established in 1964, under the charter of the National Academy of Sciences, as a parallel organization of outstanding engineers. It is autonomous in its administration and in the selection of its members, sharing with the National Academy of Sciences the responsibility for advising the federal government. The National Academy of Engineering also sponsors engineering programs aimed at meeting national needs, encourages education and research, and recognizes the superior achievements of engineers. Dr. Charles M. Vest is president of the National Academy of Engineering.

The **Institute of Medicine** was established in 1970 by the National Academy of Sciences to secure the services of eminent members of appropriate professions in the examination of policy matters pertaining to the health of the public. The Institute acts under the responsibility given to the National Academy of Sciences by its congressional charter to be an adviser to the federal government and, on its own initiative, to identify issues of medical care, research, and education. Dr. Harvey V. Fineberg is president of the Institute of Medicine.

The **National Research Council** was organized by the National Academy of Sciences in 1916 to associate the broad community of science and technology with the Academy's purposes of furthering knowledge and advising the federal government. Functioning in accordance with general policies determined by the Academy, the Council has become the principal operating agency of both the National Academy of Sciences and the National Academy of Engineering in providing services to the government, the public, and the scientific and engineering communities. The Council is administered jointly by both the Academies and the Institute of Medicine. Dr. Ralph J. Cicerone and Dr. Charles M. Vest are chair and vice chair, respectively, of the National Research Council.

The **Transportation Research Board** is one of six major divisions of the National Research Council. The mission of the Transportation Research Board is to provide leadership in transportation innovation and progress through research and information exchange, conducted within a setting that is objective, interdisciplinary, and multimodal. The Board's varied activities annually engage about 7,000 engineers, scientists, and other transportation researchers and practitioners from the public and private sectors and academia, all of whom contribute their expertise in the public interest. The program is supported by state transportation departments, federal agencies including the component administrations of the U.S. Department of Transportation, and other organizations and individuals interested in the development of transportation. www.TRB.org

www.national-academies.org

TABLE OF CONTENTS

Author Acknowledgments	vi
Abstract	vii
Executive Summary	viii
Chapter 1 – Background	1
Introduction	1
NCHRP Project 3-54/Report 493	1
Problem Statement.....	3
Objective.....	7
Scope	7
Chapter 2 – Research Approach.....	8
Research Tasks	8
Task 1 – Literature Review	8
Task 2 – Agency Contact and Data Collection.....	8
Evaluation Data.....	8
Study Database.....	9
Comparison Site Data.....	11
Task 3 – Field Data Collection	11
Task 4 – Data Analysis.....	11
Grouped Analysis.....	12
Task 5 – Report of Findings	17
Chapter 3 – Literature Review	18
FYA Literature	18
Driver Eye Movement Evaluation.....	18
Simultaneous Permissive Left-Turn Indications	20
Two Allowable Permissive Left-Turn Indications	22
Driver Comprehension of Solid Yellow Indication.....	22
Applications of the FYA in Separated Left-Turn Lanes.....	23
Driver and Pedestrian Comprehension of Requirements for Permissive Left-Turns	24
Driver Simulation.....	25
Static Driver Evaluation.....	26
Static Pedestrian Evaluation.....	26
Experimentation with Three-Section Signal Displays.....	27
Literature Review Summary.....	29
Chapter 4 – Findings & Applications	30
Research Results.....	30
Data Availability.....	30
Study Sites	30
Sign Test Results	35
Linear Trend Analysis	41
Empirical Bayes Method Statistical Analysis Results.....	45
Regression Results.....	46
Chapter 5 – Installation Methods for FYA Signals.....	52
FYA Indication Installation	52
170E Controller Setup	52
NEMA TS-2, Type 2 Controller Setup.....	52
Chapter 6 – Conclusions & Discussion.....	57
Discussion.....	57
Group A: Protected/Permissive Left-Turn Control	57

Group B: Converted from Protected Left-Turn Control.....	58
Future Evaluations.....	58
References.....	60
Appendix A – FHWA Interim Approval Memorandum	A-1
Appendix B – Conditions Report.....	B-1
Appendix C – Intersection Inventory of Treatment Sites	C-1
Appendix D – Traffic Volume Summary Tables.....	D-1
Appendix E – Intersection Inventory of Comparison Sites	E-1
Appendix F – Table Summary of Grouped Evaluation Data.....	F-1
Appendix G – Table Summary of Sites Not Included in Group Evaluation	G-1

AUTHOR ACKNOWLEDGMENTS

The research reported herein was performed under NCHRP Project 20–7, Task 222 by the Traffic Operations and Safety Laboratory at the University of Wisconsin at Madison (UW-Madison). The Board of Regents of the University of Wisconsin System was the contractor for this study, with Charles Hoffman serving as Fiscal Administrator.

David A. Noyce, Ph.D., P.E., Associate Professor of Civil Engineering at UW-Madison, was the Project Director and Principal Investigator. The other authors of this report are Casey R. Bergh, Research Assistant and M.S. Candidate at UW-Madison, and Jeremy R. Chapman, Research Assistant and Ph.D. candidate at UW-Madison. Dr. Rick Nordheim of the Department of Statistics at the University of Wisconsin-Madison provided support and review of the statistical analysis. The work was done under the general supervision of Professor Noyce at UW-Madison.

ABSTRACT

The primary objective of this research was to evaluate the safety of the flashing yellow arrow (FYA) permissive only left-turn indication field installations. The ability of the FYA indication to improve safety was evaluated with respect to crash experience. Findings of the crash analysis were interpreted with respect to other variables such as signal phasing, vehicle flow rates, posted speed limits, and intersection geometry. The scope of this research included all known installations of the FYA prior to the commencement of this research. Data were limited to that which was made available by traffic engineers in locations where the FYA has been implemented, along with selected data that were directly obtained by the researchers.

Findings were drawn from the analysis of 50 intersections in which the left-turn FYA indication was installed. Safety was improved at intersections that operated with protected/permissive left-turn (PPLT) phasing prior to field implementation of the FYA permissive only indication. Safety was not improved at intersections that operated with protected only left-turn phasing prior to field implementation of the FYA indication with PPLT phasing. The change in signal phasing had a more significant impact on safety than the change in permissive indication. No conclusions could be made at intersections that operated with permissive only left-turn phasing prior to implementation of the FYA indication, due to a minimal number of implementation sites and data. The results showed that the installation of the FYA indication for permissive left-turns provided a safety improvement when added to existing PPLT signal phasing operations.

EXECUTIVE SUMMARY

Accommodating left-turn movements at signalized intersections provides a challenge to traffic engineers. In order to complete a left-turn at a signalized intersection, the driver must either find an appropriate gap in the opposing traffic stream or have all conflicting traffic stopped. As a result of this conflict of movements, successfully accommodating left-turn and opposing through movement vehicles is critical to the safe and efficient operation of signalized intersections.

Traffic engineers use different phasing schemes within the signal cycle, namely permissive only, protected, or a combination of both phases, to accommodate left-turn movements at signalized intersections. Permissive only left-turn phasing allows vehicles to complete a left-turn during the green phase after yielding to opposing through traffic and pedestrians. Protected left-turn phasing provides right-of-way to the left-turn vehicle during a specified green phase in which a green arrow indication is displayed. Protected/permissive left-turn phasing uses both left-turn phases in the same signal cycle, as a leading, lagging, or lead-lag protected/permissive left-turn (PPLT) phase, depending on whether the protected phase precedes or follows the opposing through traffic in sequence.

A comprehensive research study, titled “Evaluation of Traffic Signal Displays for Protected/Permissive Left-Turn Control,” was completed in 2003 for The National Cooperative Highway Research Program (NCHRP) as Project 3-54. The corresponding report, NCHRP Report 493, presented the findings of an extensive array of studies conducted to evaluate all currently used permissive only left-turn indications.

Traffic engineers around the country had implemented a variety of unique permissive only left-turn signal indications in an attempt to better communicate to the left-turn driver that they must yield to opposing through traffic before turning. It was perceived that drivers did not adequately comprehend the predominant permissive only display in use, the circular green (CG) permissive only left-turn indication, because of increases in left-turn crashes and decreases in operational efficiency. Therefore, a number of unique permissive only left turn indications were implemented in an attempt to resolve the problem including the flashing red arrow (FRA), flashing circular red (FCR), flashing yellow arrow (FYA), and flashing circular yellow (FCY). Research was needed to evaluate each of these and determine which was most effective and could be uniformly applied throughout the United States (U.S.). To complete this research, a comprehensive array of research studies and experiments were completed including driver behavior laboratory analyses, operational and behavioral field evaluations, and full-scale driving simulator analyses.

NCHRP Report 493 recommended the use of a flashing yellow arrow indication as the desired permissive only indication when using protected/permissive left-turn (PPLT) signal phasing. The report cited that the flashing yellow arrow had a high level of driver comprehension, overcame many of the human factors issues with permissive only left-turns, and was shown to have the most versatile characteristics of all the permissive only displays studied. Furthermore, the FYA had an important safety characteristic; drivers who did not understand the meaning of the FYA tended to yield, which is a desirable failure outcome. This was in contrast to drivers who did not understand the meaning of the CG, in which case drivers tended to assume right-of-way and go, a very undesirable outcome.

After the conclusion of the NCHRP 3-54 research, a number of traffic engineers around the U.S. considered implementing a FYA permissive only indication. Between January 1, 2004

and March 20, 2006, the Federal Highway Administration (FHWA) approved numerous 'Requests for Experimentation' allowing a widespread implementation of the FYA. Additionally, between March 20, 2006 and the date of this report, the FHWA has granted permission for further implementations of the FYA under an 'Interim Approval' designation. Despite several research studies and experiments that were recently completed after NCHRP Report 493, questions remain as the FYA implementation continues. Specifically, a question remains as to how the implementation of the FYA has impacted the safety of the nearly 300 intersections which now use a FYA permissive only left-turn indication. Therefore, a need exists to quantitatively evaluate the safety of the intersections implemented with the FYA indication and to qualitatively document the experiences of each implementation agency. A greater understanding of the safety (crash experience) and driver behavior before and after the installation of the FYA will greatly assist traffic engineers as they consider incorporating the FYA into the transportation system.

The primary objective of this research was to evaluate the safety effectiveness of the FYA permissive left-turn indication field installations. The ability of the FYA indication to improve safety was evaluated with respect to crash experience. Findings of the crash analysis were interpreted with respect to other variables such as signal phasing, vehicle flow rates, posted speed limits, and intersection geometry. The scope of this research included all known installations of the FYA prior to the commencement of this research. Data were limited to that which was made available by traffic engineers in locations where the FYA has been implemented, along with selected data that were directly obtained by the researchers.

Five tasks were included in the study design. These tasks included extensive amounts of data collection, working with traffic engineers at each location to obtain the necessary information, and a statistical analysis of the data obtained.

Of the nearly 300 intersections reportedly implementing the FYA indication, documentation and data was only available for approximately 120 locations throughout the U.S. at the time of this research. These sites represent a widely varied cross-section of intersection types and sizes. None of the intersections in which the FYA indication was implemented was without some selection bias or without some change in operating conditions before and after the installation. Furthermore, none of the sites in which traffic engineers provided data were complete or comprehensive in terms of obtaining all desirable data for analysis. Nevertheless, the affects of a change in left-turn phasing and/or the implementation of the FYA indication were analyzed.

This research resulted in three general conclusions:

- Safety was improved at intersections that operated with PPLT phasing prior to field implementation of the FYA permissive indication with PPLT phasing.
- Safety was not improved at intersections that operated with protected only left-turn phasing prior to field implementation of the FYA permissive indication with PPLT phasing.
- No conclusions could be made at intersections that operated with permissive only left-turn phasing prior to implementation of the FYA indication, due to a minimal number of implementation sites and data.

The installation of the FYA indication at sites which currently operate PPLT signal phasing showed improvements in safety. In other locations, the change in left-turn signal

phasing had a more significant impact on safety than the change in left-turn indication, although safety appeared to improve with time.

Information was also provided related to traffic signal controller logic and the physical installations of the FYA installation.

CHAPTER 1 – BACKGROUND

Introduction

Accommodating left-turn movements at signalized intersections provides a challenge to traffic engineers. In order to complete a left-turn at a signalized intersection, the driver must either find an appropriate gap in the opposing traffic stream or have all conflicting traffic stopped. As a result of this conflict of movements, successfully accommodating left-turn and opposing through movement vehicles is critical to the safe and efficient operation of signalized intersections.

Traffic engineers use different phasing schemes within the signal cycle, namely permissive only, protected, or a combination of both phases, to accommodate left-turn movements at signalized intersections. Permissive only left-turn phasing allows vehicles to complete a left-turn during the green phase after yielding to opposing through traffic and pedestrians. Protected left-turn phasing provides right-of-way to the left-turn vehicle during a specified green phase in which a green arrow indication is displayed. Protected/permissive left-turn phasing uses both left-turn phases in the same signal cycle, as a leading, lagging, or lead-lag protected/permissive left-turn (PPLT) phase, depending on whether the protected phase precedes or follows the opposing through traffic in sequence.

To increase the operational efficiency on transportation corridors, some traffic engineers will employ a leading protected left-turn phase in one direction and a lagging protected left-turn phase in the opposite direction, with permissive only left-turn operations in between. This ‘lead-lag’ PPLT signal phasing can be operationally advantageous, but has traditionally led to a safety problem deemed the “yellow trap.” Researchers and traffic engineers have identified several phasing methods to overcome the yellow trap. For example, Dallas phasing maintains the permissive left-turn indication throughout the cycle which eliminates the yellow trap scenario. Left-turn phasing recommended with the recently introduced flashing yellow arrow (FYA) permissive left-turn indication also provides a successful way to accommodate left-turn operations without impacting the safety of signalized intersections.

NCHRP Project 3-54/Report 493

A comprehensive research study titled, “Evaluation of Traffic Signal Displays for Protected/Permissive Left-Turn Control,” was completed in 2003 for The National Cooperative Highway Research Program (NCHRP) as Project 3-54. The corresponding report, NCHRP Report 493, presented the findings of an extensive array of studies conducted to evaluate all currently used permissive left-turn indications (1).

Traffic engineers around the country had implemented a variety of unique permissive left-turn signal indications in an attempt to better communicate to the left-turn driver that they must yield to opposing through traffic before turning. It was perceived that drivers did not adequately comprehend the predominant permissive indication in use, the circular green (CG) permissive left-turn indication, because of increases in left-turn crashes and decreases in operational efficiency. Therefore, a number of unique permissive left turn indications were implemented in an attempt to resolve the problem including the flashing red arrow (FRA), flashing circular red (FCR), flashing yellow arrow (FYA), and flashing circular yellow (FCY). Research was needed to evaluate each of these and determine which was most effective and could be uniformly applied throughout the U.S. To accomplish this research, a comprehensive

array of research studies and experiments were completed including driver behavior laboratory analyses, operational and behavioral field evaluations, and full-scale driving simulator analyses.

NCHRP Report 493 recommended the use of a flashing yellow arrow indication as the desired permissive indication when using protected/permissive left-turn (PPLT) signal phasing. The report cited that the flashing yellow arrow had a high level of driver comprehension, overcame many of the human factors issues with permissive left-turns, and was shown to have the most versatile characteristics of all the permissive displays studied. Furthermore, the FYA had an important safety characteristic; drivers who did not understand the meaning of the FYA tended to yield, which is a desirable failure outcome. This was in contrast to drivers who did not understand the meaning of the CG, in which case drivers tended to assume right-of-way and go, a very undesirable outcome.

To further evaluate the effectiveness of the FYA permissive indication, an extensive campaign was initiated near the end of the NCHRP 3-54 research to find state and municipal traffic engineers who were willing to implement and evaluate the FYA indication at operating signalized intersections. The first volunteer agency to experiment with the FYA was Montgomery County, Maryland. In September of 2000, Montgomery County implemented the FYA indication at three different signalized intersections. Between September of 2000 and June of 2002 five additional agencies implemented the FYA, namely, Tucson, Arizona; Jackson County, Oregon; Oregon Department of Transportation; Beaverton, Oregon; and, Broward County, Florida. Table 1 summarizes the initial participants and the number of intersections in which the FYA indication was implemented.

As part of the NCHRP 3-54 research, each of these sites were visited and videotaped in an effort to complete a surrogate before and after analysis of the FYA indication in which some basic traffic conflict and operational elements were evaluated. The term surrogate is used since the project timeline did not allow for a sufficient 'after' period to effectively evaluate each field installation. Therefore, between 8 and 24 hours of video were collected and analyzed at each site, before and after the installation of the FYA. The findings of this effort, reported in NCHRP Report 493, showed no significant difference in safety (conflicts) and operations (flow rate and headways) in the initial period after the implementation of the FYA.

As a further evaluation of the FYA, members of the NCHRP research team were present for the initial 'turn on' of the FYA at several locations. The hypothesis (at the time) was that drivers may be initially confused by the FYA leading to erratic driving behavior and a series of traffic incidents. It is important to note that this hypothesis was not supported by the NCHRP 3-54 research team as driver understanding was evaluated extensively and was found to be extremely high in all experimental analyses. The results of this investigation found no significant change in traffic operations, or obvious driver confusion, during the initial turn on of the FYA or in periods shortly thereafter. Results supported the laboratory and driving simulator findings.

TABLE 1 Summary of Initial FYA Implementation Sites

Agency	Implementation Date	Number of Implementation Sites
Montgomery County, Maryland	September 2000	3
City of Tucson, Arizona	May 2001	3
Jackson County, Oregon	May 2001	1
Oregon Department of Transportation	June 2001	2
City of Beaverton, Oregon	April 2002	3
Broward County, Florida	June 2002	3

Problem Statement

After the conclusion of the NCHRP 3-54 research, a number of traffic engineers around the U.S. considered implementing a FYA permissive indication. Between January 1, 2004 and March 20, 2006, the Federal Highway Administration (FHWA) approved numerous ‘Requests for Experimentation’ allowing a widespread implementation of the FYA. A summary of the number of locations initially approved, by state, is presented in Figure 4. It is interesting to note that several of these requests were ‘repeat customers’ who had local success with earlier installations of the FYA and subsequently requested approval to install the FYA at additional intersections. Figures 1 through 3 present photos of field installations of the FYA.

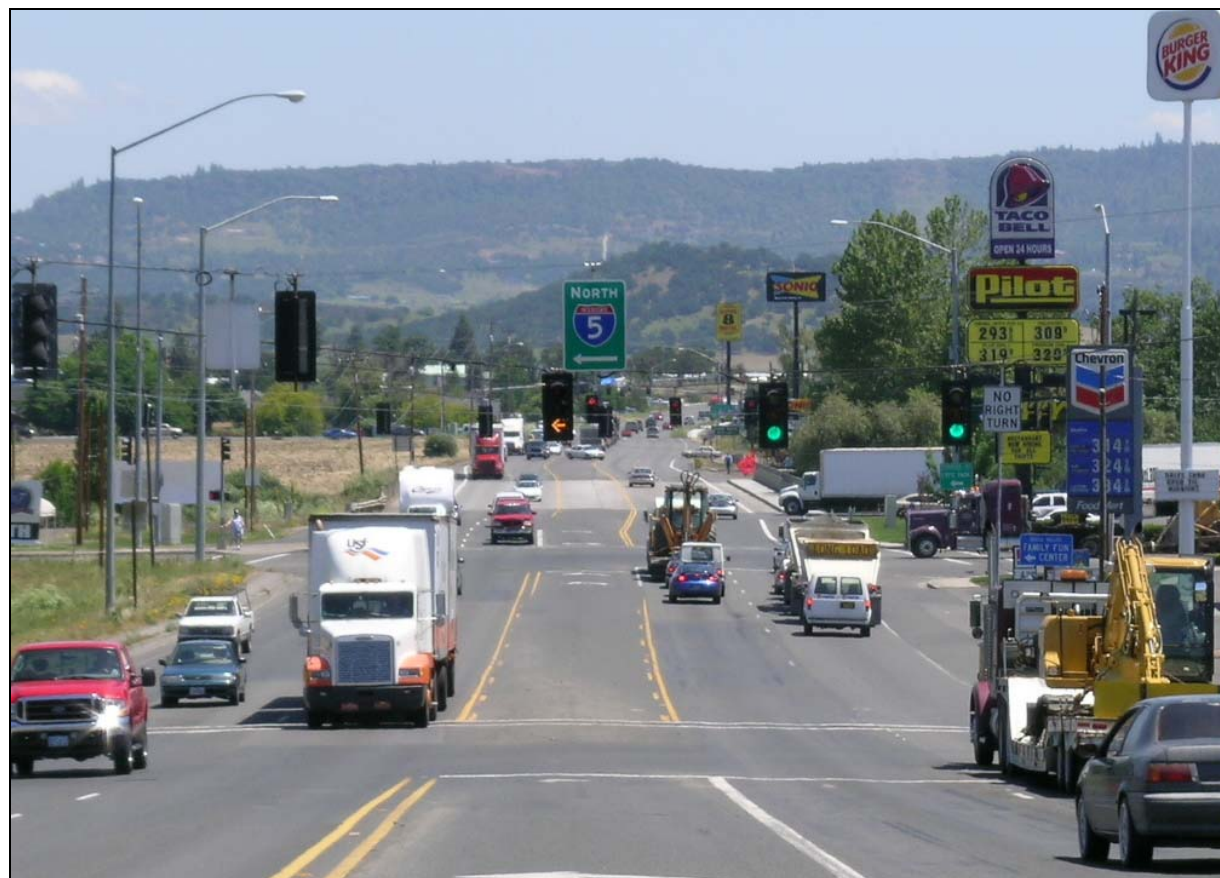

FIGURE 1 Permissive Flashing Yellow Arrow in Operation in Jackson County, Oregon

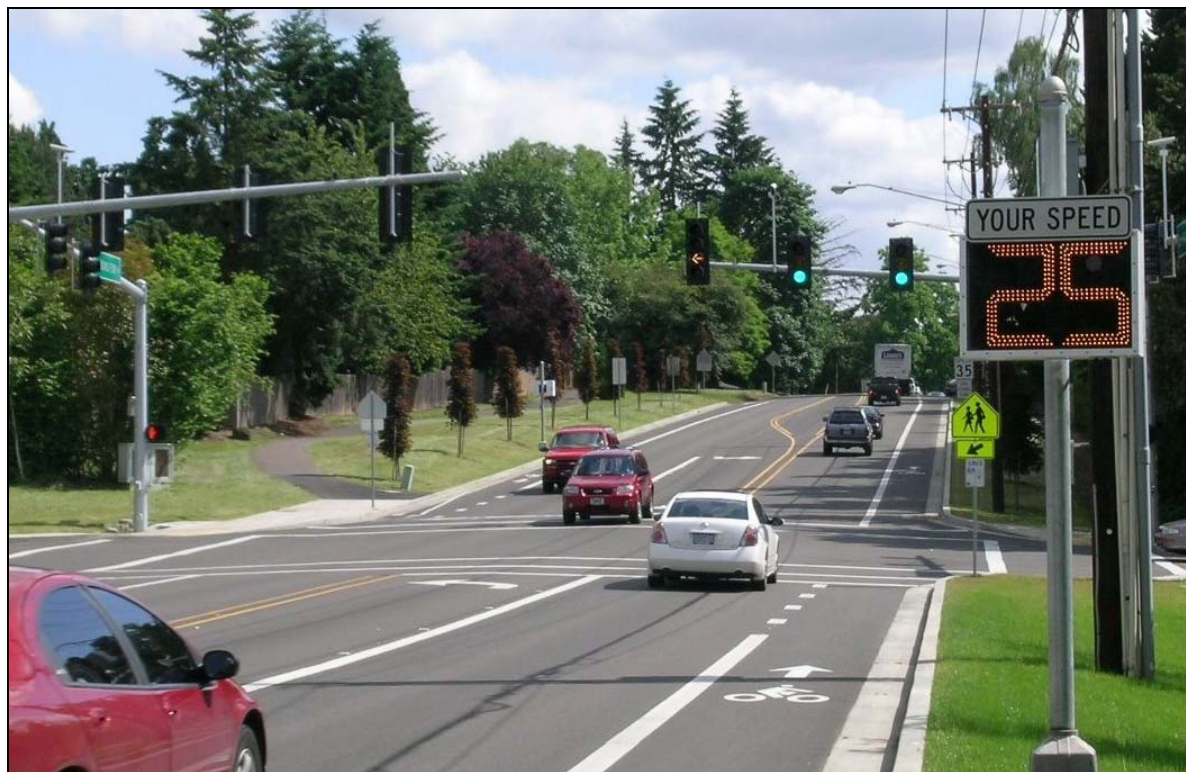

FIGURE 2 Permissive Flashing Yellow Arrow in Operation in Tualatin, Oregon

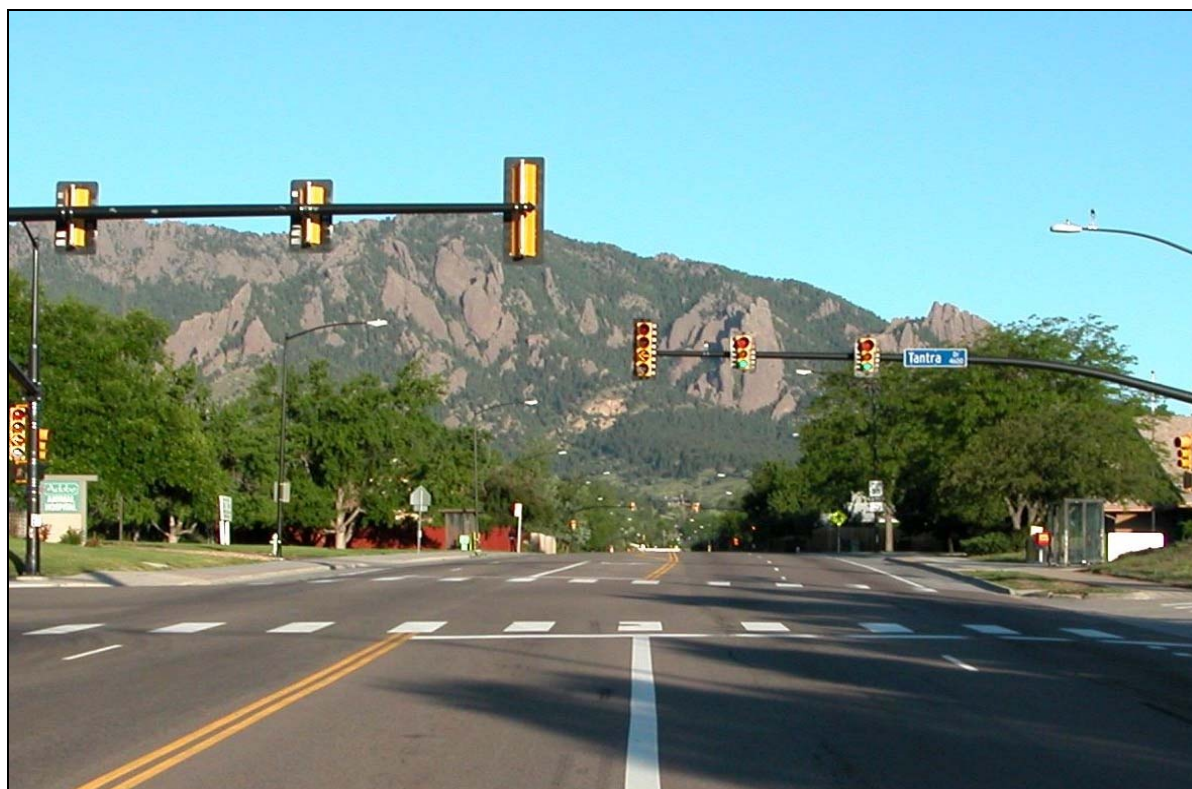

FIGURE 3 Permissive Flashing Yellow Arrow in Operation in Boulder, Colorado

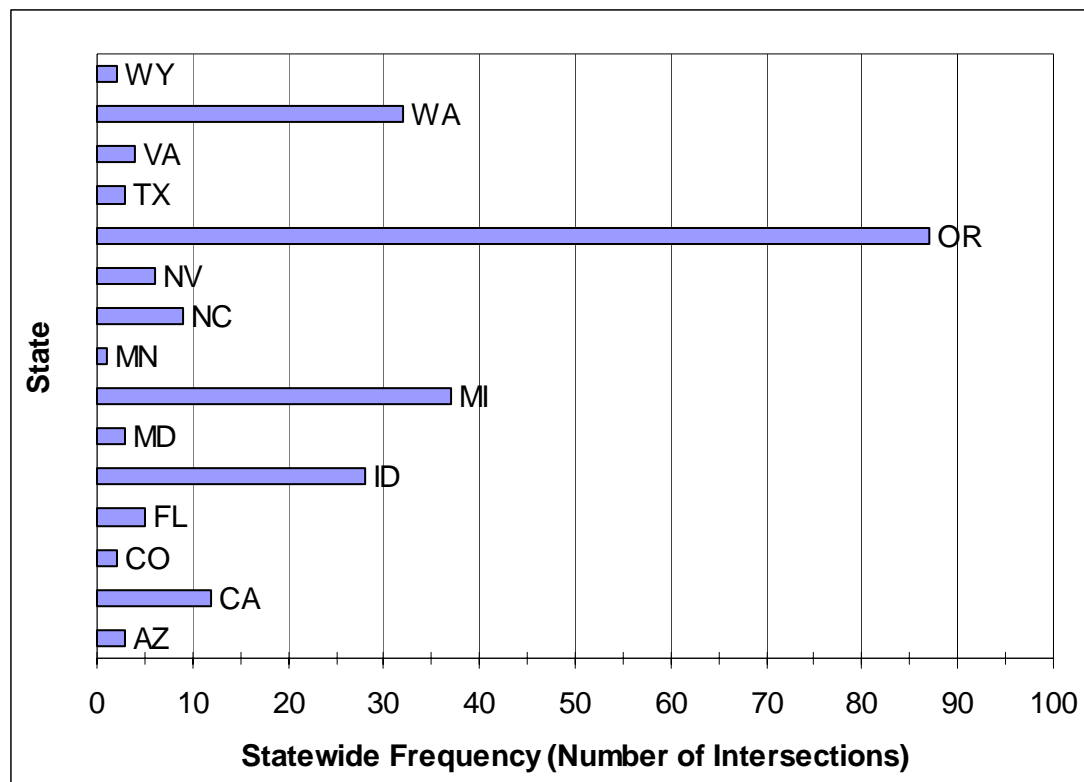

FIGURE 4 National Distribution of FHWA Flashing Yellow Arrow Experimentation Sites

On March 20, 2006, FHWA began to approve jurisdictions for implementation of the FYA through an Interim Approval (IA), given that support for implementation of the FYA had continued nationally (2). A copy of the memo that announced the IA status of the FYA is included in Appendix A. As stated by FHWA, the IA “allows interim use, pending official rulemaking, of a new traffic control device, a revision to the application or manner of use of an existing traffic control device, or a provision not specifically described in the Manual on Uniform Traffic Control Devices (MUTCD).” Previous FYA research results and drivers’ observed understanding of the FYA indication were cited as the impetus for the interim approval. After the distribution of the IA, several states, counties, and cities applied for approval to implement the FYA. Table 2 provides a summary of these locations.

By June 15, 2007, IA requests had been approved by FHWA for various levels of state and/or local municipalities in 16 states. Approvals for implementation of the FYA included all jurisdictions within five states, all state-owned highways in five other states, and in 13 individual cities throughout eleven states.

TABLE 2 Summary of Interim Approval Locations

State	Jurisdiction	Interim Approval*
AR	Fort Smith	City Streets
CA	El Cajon	City Streets
	Fullerton	City Streets
	Pasadena	City Streets
	Victorville	City Streets
	Santee	City Streets
CO	CDOT	State Highways
ID	Coeur d' Alene	City Streets
	ITD	State Highways
GA	Alpharetta	City Streets
LA	Lafayette	City Streets
MI	MDOT	All Jurisdictions
MN	MN/DOT	All Jurisdictions
MO	MoDOT	State Highways
NC	Fayetteville	City Streets
	NCDOT	State Highways
NM	Farmington	City Streets
OR	ODOT	All Jurisdictions
TX	Garland	City Streets
UT	UDOT	All Jurisdictions
WA	WSDOT	All Jurisdictions
WY	Cheyenne	City Streets
	WYDOT	State Highways

* As of June 15, 2007

The adoption of the NCHRP Report 493 results, and the rapid implementation of the FYA, created a need for changes to the MUTCD to allow the use of a FYA permissive left-turn indication. The Signals Technical Committee, part of the National Committee on Uniform Traffic Control Devices (NCUTCD), was tasked with the process of developing the appropriate changes to the MUTCD. To date, recommendations have been made to add a new section to the MUTCD (4D.06A) that will provide engineers the option of using the FYA permissive left-turn indication (3). The proposed section may be applied on an individual intersection approach or to multiple approaches, and will set forth revised standards for displaying each mode of left-turn phasing. To provide a comprehensive update to the manual and incorporate the option of the FYA display and its intended meaning, the following MUTCD sections may also be modified to accommodate the FYA language:

- Section 4D.04 Meaning of Vehicular Signal Indications
- Section 4D.05 Application of Steady Signal Indications
- Section 4D.06 Application of Steady Signal Indications for Left Turns
- Section 4D.07 Application of Steady Signal Indications for Right Turns
- Section 4D.08 Prohibited Signal Indications
- Section 4D.16 Number and Arrangement of Signal Sections in Vehicular Traffic Control Signal Faces

Despite several research studies and experiments that were recently completed after NCHRP Report 493 (4,5,6,7,8,9,10), questions remain as the FYA implementation continues. Specifically, a question remains as to how the implementation of the FYA has impacted the safety of the nearly 300 intersections which now use a FYA permissive left-turn indication.

Therefore, a need exists to quantitatively evaluate the safety of the intersections implemented with the FYA indication and to qualitatively document the experiences of each implementation agency. A greater understanding of the safety (crash experience) and driver behavior before and after the installation of the FYA will greatly assist traffic engineers as they continue to incorporate the FYA into the transportation system.

Objective

The primary objective of this research was to evaluate the safety effectiveness of the FYA permissive left-turn indication field installations. The ability of the FYA indication to improve safety was evaluated with respect to crash experience. Findings of the crash analysis were interpreted with respect to other variables such as signal phasing, vehicle flow rates, posted speed limits, and intersection geometry.

Scope

The scope of this research included all known installations of the FYA prior to the commencement of this research. Data were limited to that which was made available by traffic engineers in locations where the FYA has been implemented, along with selected data that were directly obtained by the researchers.

CHAPTER 2 – RESEARCH APPROACH

Research Tasks

Five tasks were created to evaluate the effectiveness of the FYA permissive indication field installations with respect to safety. Each task is briefly described below.

Task 1 – Literature Review

Literature pertaining to the use of the FYA permissive indication is comprehensively documented in NCHRP Report 493. Literature published after the completion of NCHRP Report 493 was reviewed, and special attention was given to T-intersections and wide median issues. The literature review included various professional and peer-reviewed journals and other published and unpublished documentation. A literature review is presented in Chapter 3 of this report.

Task 2 – Agency Contact and Data Collection

Each agency that had submitted an official ‘request for experimentation’ to FHWA prior to March 20, 2006 to implement the FYA permissive indication was contacted for participation in this research. Information on each site was obtained from the ‘Request for Experimentation’ applications. To supplement this information, a ‘Conditions Report’ form was created and sent to each experimenting agency. Comments and suggestions from the NCHRP Panel were implemented in the development of the data request. The Conditions Report, presented in Appendix B, solicited much of the same information required by FHWA as part of the agency’s agreement in the Request for Experimentation. Specifically, the report was designed to obtain detailed information on the traffic signal operations, geometric design, and safety of the intersections being evaluated. Information pertaining to traffic control data for the period prior to implementation of the FYA, crash data, traffic volume data, and geometric data were requested. Unfortunately, many traffic agencies were not able to provide this information at a level of detail needed for analysis.

In an attempt to overcome the gaps in available data, direct contact was made and maintained with multiple implementation agencies throughout the entirety of the research. All data that were available at the time of the study were collected and included in this analysis.

Evaluation Data

Data essential for evaluation included ‘before’ and ‘after’ crash data and supporting information about the intersection such as traffic volume (ideally turning movement counts), signal timing, geometry, and adjacent land use. A minimum of three years of crash data were obtained for the time period prior to implementation of the FYA indication. Crash data available ‘after’ implementation were obtained from the date of installation to the most recent date for which data were available. When available, actual crash reports were acquired to obtain all information known about the reported crashes. Data from similar intersections which were not implemented with the FYA were requested as ‘comparison sites’ to allow for more robust statistical analysis of the changes in safety.

Geometric and land use information for each implementation intersection was used to help identify any confounding factors that may impact the safety of the FYA implementation.

Elements that were considered included the number of intersection approaches, number of through lanes opposing each left-turn, median width, opposing left-turn offset distance, and approach grade. Also, any significant changes in land use that significantly impacted traffic volumes or operations would disqualify an intersection from evaluation.

Data related to signal timing of the intersection and pertinent operational data ‘before’ and ‘after’ the FYA installation were requested. Impact of changes in signal timing parameters for the left-turning traffic was evaluated.

Study Database

The FYA indications implementations to date include a variety of field conditions in multiple states. At each implementation site, geometry, vehicular flow, traffic control, and driver population varied. The FYA has also been implemented in a variety of environments including urban coordinated corridors, isolated rural intersections, and suburban residential neighborhoods. Additionally, each state or municipality that chose to implement the FYA indication did so based on different motivational factors. In several cases, all intersections within a coordinated corridor were implemented. In other municipalities, sites were individually selected to address a safety concern.

While some agencies have maintained a comprehensive dataset for each experimental site, others only had minimal data available for evaluation. Chapter 4 further describes the data included in the study database. Given the uniqueness of each site, it was important to document the specific attributes associated with the before and after crash data. Appendix C provides a detailed description of each study site, including a description of the operations, geometry, and before and after safety (crash) findings. All known details pertaining to changes made at each intersection are also included.

Traffic Volumes. To determine a level of exposure for each FYA installation, traffic volume data was requested from each agency. Data were acquired in a variety of formats and in varying levels of detail. Some jurisdictions provided detailed turning movement counts, others provided 24-hour corridor counts, and others only provided estimates of daily volumes.

The most effective means to measure exposure to the FYA was expected to be the count of left-turning vehicles conflicting with the count of opposing through vehicles. To quantify this, the product of the left-turning volume on each FYA approach along with the ratio of the opposing through volume to the number of opposing through lanes was desired. Unfortunately, these data were not collected and/or provided by many jurisdictions and did not allow this measure to be included throughout the evaluation.

Where volume data were not available for individual turning movements, an estimate of the Average Daily Traffic (ADT) was reported. In many cases, an hourly turning movement count was used to estimate daily volume by applying an adjustment factor to the hourly count. In order to obtain a measure of exposure in the before and after periods, exponential growth rates were developed from count data collected in two separate years and applied to appropriately estimate the missing count. However, not all sites had volume counts for two time periods. In order to complete the dataset, growth estimates were developed from many different sources including city master plans, regional growth estimates, and arterial counts within a reasonable distance from the intersection. Other methods were used when appropriate (11). Appendix D includes a summary of traffic volume data collected for the study sites.

Geometry. Typical geometric features of intersections were summarized for each study location. The safety of left-turning vehicles was expected to be primarily dependant on the following geometric parameters:

- Number of intersection approaches;
- Number of exclusive left-turn lanes on each approach;
- Number of through lanes (exclusive or shared) that oppose a left-turn movement; and,
- Travel speeds on intersection approaches with FYA.

Crash Data. Where data was available, each crash record provided by experimental jurisdictions was summarized by crash type, severity, and weather conditions. Due to variations between agencies and crash databases it was necessary to define each crash type to maintain as much consistency as possible. The crash types were summarized in the study using the following classifications:

Angle: Crash occurring between two vehicles at 45- to 150-degrees to one another. Examples of angle crashes include right-turning vehicles with perpendicular flowing vehicles or two vehicles colliding after arriving on two intersecting roads, likely at 90-degrees. Common causes of crashes in this category include “failure to obey traffic control” (i.e., disregard signal) or “improper turn.”

Left-Turn: All crashes that occurred at an intersection that involved a left-turning vehicle. U-turn crashes were also included if the crash was not related to an inability to make the turn within the given roadway width.

Side-Swipe: Crashes that included side-to-side impact between two vehicles. Usually impact occurs at less than a 30-degree angle.

Rear-End: Collision occurring primarily between the front of one vehicle and the rear of another.

Fixed Object: One vehicle in motion collided with an object that is in the roadway or on the roadside, including parked vehicles.

Pedestrian/Bicycle: Crashes including a pedestrian or bicyclist regardless of who was at fault.

Other: Crashes that did not fall into the above categories include: head-on crashes not associated with a turning vehicle, backing vehicle, run-off road, and uncategorized crashes.

FYA Left-Turn Crash: A ‘target’ crash group was created in order to isolate the effect of the FYA on the crash frequency at each intersection. Target crashes include those that involved a vehicle making a left-turn from an approach where an FYA display was installed. In the ‘before’ period, a left-turn crash was considered a target crash if it occurred on an approach later implemented with the FYA. If a second vehicle was involved in the crash with the left-turning vehicle, it may or may not have been an opposing through movement.

Comparison Site Data

Comparison site data were collected to gain an understanding of the safety trends at intersections similar to the treated location, but without the implemented of a FYA. Including comparison sites in the evaluation could help isolate the effect of the treatment (FYA indication) on the safety of the intersections by exploring the trends at similar sites without the treatment. The comparison sites were selected by each experimenting agency given the following basic guidelines:

- Similar left-turn control on the major approaches as that used prior to implementation of the FYA at the treatment site (e.g., protected, permitted, or PPLT). Where the FYA was installed on the major street approach, the comparison site was controlled with a similar phasing on the major street approach. In many cases the minor street approach at the comparison site also used similar phasing as the treatment, but not always.
- Similar major and minor street volumes with respect to number of through lanes.
- Similar scale of geometric features including number of intersection approaches.

A total of 19 comparison sites were considered in this study. Comparison site data are summarized in Appendix E.

Task 3 – Field Data Collection

Field visits were made to two geographical locations to review the operations of the FYA, obtain relevant data, and interview the traffic engineer responsible for the installation. Photo and video documentation of field operations at each site visited were obtained to evaluate the left-turn operational conditions at selected intersections. Specific attention was given to implementation procedures and documentation of the signal configuration.

In June 2006, visits were made to jurisdictions throughout Oregon, Washington, and Idaho. At that time over one-third of all experimental sites implemented were in those three states. Three of the original agencies to experiment with the FYA were in Oregon. Sites in Maryland and Virginia were visited in January 2007. Photos and video data obtained during these visits are posted on the UW-Madison Traffic Operations and Safety Laboratory website at <http://www.topslab.wisc.edu/projects/fya.htm>.

Task 4 – Data Analysis

Evaluation of the crash history of the study sites was conducted on various levels. A general examination of the empirical data collected at the study intersections revealed trends in the crash history. Statistical methods were utilized to further investigate the reliability of those trends.

Analysis compared crash history data obtained prior to the implementation of the FYA display with that obtained over various time periods after implementation. The underlying assumption in this analysis was that the only variable resulting in any change in operational or safety characteristics was the conversion of the left-turn indication itself. This methodology excludes the potential impact of other variables (e.g., changes in network travel patterns) on the effects observed during the study period.

Initial investigation of the study sites revealed that major changes occurred at several study sites between the before and after periods. Examples of changes included geometric

modifications to the intersection, construction of private development on an adjacent property with access to the intersection, and changes in local travel patterns and traffic volumes. In these cases, use of the data was either restricted to individual intersection analysis and ‘information only’ data presentations, or the data was eliminated from the database and removed from the analysis.

Study intersections where no major changes are known to have occurred over the study period were grouped for analysis based on the type of left-turn control used prior to implementation of the FYA display. This report references three analysis groups, namely Protected and Permitted (PPLT), Protected Only, and Permitted Only. Appendix F provides a list of the sites selected within each group and the date of the FYA installation at each.

A statistical evaluation of individual sites where significant changes were known to have occurred during the study period was not completed. Appendix G provides a summary table of the sites that were not included in the grouped evaluation.

Grouped Analysis

Two statistical comparisons were made between the crash history data recorded before and after implementation of the FYA display. The first, a sign test, was conducted between the crashes recorded in the period before implementation, with those recorded during the after period. The second comparison was made between the frequencies of crashes recorded in the after period with a linear expectation of the crash frequency that would have occurred in the after period should the treatment not have been implemented.

Sign Test. In a large number of situations the sign test is a simple but valuable statistical method for transportation data analysis. The sign test was used in this study as an initial measure to determine whether the average annual frequency of crashes increased or decreased at the experimental intersections after implementation of the FYA indication. The test was carried out by assigning a negative sign to those intersections where a reduction in the average annual crash frequency was observed and a positive sign at those intersections where an increase was observed.

The number of negative signs determined from the sign test follows a binomial distribution with the probability, p , equal to the probability of that sign being tested. Binomial distribution tables give a critical value for the test that will determine whether to reject the null hypothesis.

Letting p indicate the proportion of sites that decreased in crash frequency, the following hypothesis was developed:

$$H_0: p = 0.50$$

$$H_a: p \neq 0.50$$

If H_0 cannot be rejected, there is no evidence to indicate that a change occurred in the crash frequency after implementation. However, if H_0 can be rejected, there is evidence to conclude that the crash frequency either increased or decreased after implementation of the FYA. In that case, the sign that is most common can be considered more likely than the other.

The binomial distribution is given by,

$$b(x; n, p) = \binom{n}{x} p^x (1 - p)^{n-x} \quad (1)$$

Where,

n = number of trials,

x = number of observations in one direction, and

p = success probability

The binomial distribution was used to determine the probability of obtaining the observed result (number of negative signs) or a more extreme result. A two-tailed test with a significance level of 95-percent was employed.

Linear Trend Analysis. The linear trend analysis was used to estimate an expected crash frequency rate assuming that no major changes had been made to a particular intersection. This linear trend line used available before data and was compared with the observed frequency of crashes that were reported in the period after implementation of the FYA display. A linear trend comparison did provide a pictorial comparison to observe trends in crash frequency that may be prevalent in the years prior to FYA implementation.

Empirical Bayes (EB) Analysis. Several of the study sites were reportedly selected for conversion to a FYA permissive indication specifically to address a safety need, thereby potentially introducing a selection bias. Several statistical methods were considered for use in this study to help account for this bias, including the Empirical Bayes (EB) methodology. The EB approach employs reference population data to predict what the crash frequency in the after period would have been, had the treatment not been applied. Given the small size of the available data sets, along with the potential for the regression-to-the-mean bias, the EB approach was included to help identify statistically significant changes in left-turn crashes. One of the drawbacks to this methodology with small data sets was the potential for large variances, making it difficult to detect statistically significant changes in crash frequency.

The method of moments and Poisson regression models were considered to define the reference population. Both population crash mean and crashes counts at the selected intersections were used to estimate the expected crashes for the specific intersections if the FYA treatment has not been applied to the intersection. Computations to determine the expected number of crashes at the selected intersections were completed using the methods described by Hauer (17).

Nineteen intersections had sufficient data to be included in this analysis. Estimates of the population mean and variance were obtained. Next, a weighting factor was computed and used to estimate the conditional mean and conditional variance of each intersection. The expected crashes at the selected intersections were compared to the crashes with the FYA treatment. Because the variance was estimated, a t distribution was used to evaluate the significance of the change of expected crashes versus observed crashes. A significance level of 0.20 was used given the small sample size.

Regression Analysis. Regression techniques were applied to identify which variables were correlated with the change in crash frequency observed after implementation of the FYA display. These techniques also led to the development of a mathematical model that estimated the response or outcome event given predictor variables.

One of the key assumptions of linear regression is that the response is continuous; that is, it can take on any value within a range of values. The response variables analyzed in this study are an average annual frequency of crashes, which met this requirement. Crash data is typically considered to be a form of count data, which consists of discrete non-negative integer values. Application of standard least squares regression techniques to count data typically results in inconsistencies with the nature of count data because it may yield non-integer predicted values and can result in negative values (13). The assumptions inherent to linear regression of linearity between dependent and independent variables, independence of the errors, homoscedasticity of the errors, and normality of the error distribution were considered. With discrete count data, the Poisson and negative binomial regression models are the most commonly used.

Neter et al. states that when the observed variable Y is a count variable, a square root transformation is helpful for stabilizing the variances (14). Therefore, a square root transformation was applied to the response variable. Figures 5 and 6 show example histograms of the average annual crash frequency after implementation of the FYA at Group A sites, with and without the square root transformation, respectively. As shown in Figures 5 and 6, the square root transformation reduced the variation in the response variable and shifted the distribution to better approximate a Gaussian distribution.

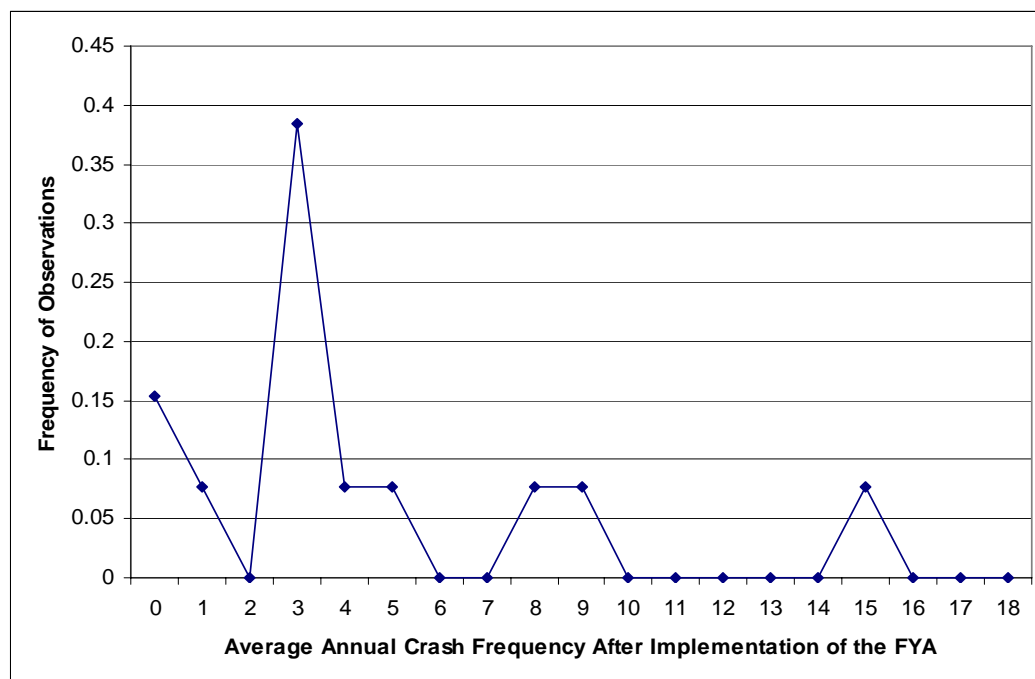

FIGURE 5 Total Crash Histogram of Group A Sites

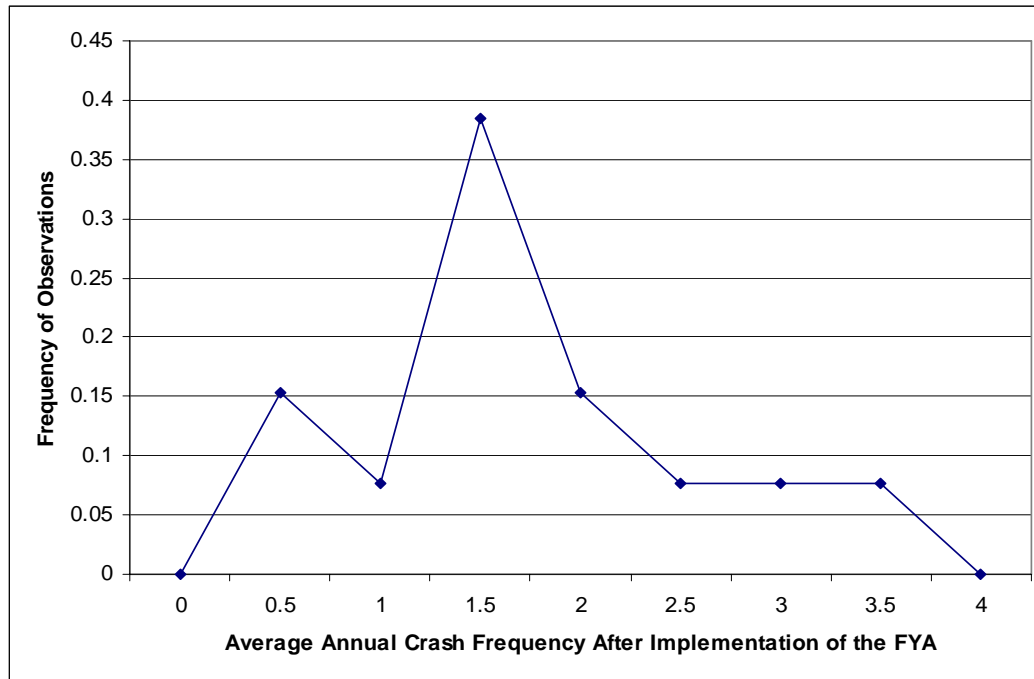

FIGURE 6 Total Crash Histogram of Group A Sites After Transformation

Study Variables. Independent variables included both covariates (i.e., continuous factors) and discrete factors. The covariates included:

- Average Daily Traffic (ADT), Before and After
 - The bi-directional estimate of average annual traffic volume approaching the intersection.
- Volume Ratio
 - The ratio (after/before) of ADT estimates with respect to date of implementation.
- Before Crash Frequency
 - The average annual crash frequency during the period for which data was available prior to implementation of the FYA display.
- Before Left-turn Crash Frequency
 - The average annual frequency of left-turn crashes during the period for which data were available prior to implementation of the FYA display.
- Before FYA Approach Left-turn Crash Frequency
 - The average annual frequency of left-turn crashes that involved a vehicle entering the intersection from an approach planned for implementation with the FYA indication, during the period for which data was available prior to the implementation of the FYA display.

The discrete factors included (levels in parenthesis):

- Number of FYA Approaches
 - The number of left-turn approaches that have been implemented with the FYA display. Intersections included three or four approaches with implementation occurring on one, two, or four approaches.
- Previous Left-turn Display
 - The display used prior to the implementation of the FYA, which included three-section, four-section, or a five-section cluster/doghouse.
- Number of Opposing Through Lanes
 - The number of through lanes opposing the implemented FYA left-turn approach.
- Number of Months of After Data
 - The number of months for which crash data were provided after implementation.

Many other variables were of interest, such as left-turn movement volume, regional driver characteristics, intersection capacity, percent of cycle devoted to the permissive phase, and average travel speed on intersection approaches. Due to this data being unavailable or inconsistent, these variables could not be included in the regression analysis.

An alternative response variable was also examined and found to provide insignificant results. The percent change between the before and after periods was evaluated as a response variable. Several of the best models identified through a best subset analysis did not include variables that were significant at a 0.10 level.

Selection of Model. Analysis of various subsets of predictor variables helped identify which individual variables and which combinations of variables best model the observed conditions. For each dataset evaluated, a model was selected based on the largest adjusted R-squared values calculated for each subset of variables (15). Where the selected model contained more than two independent variables, a backwards stepwise analysis was performed to determine which variables were significant at a 95-percent confidence level.

Regression analysis was conducted for intersections grouped by the type of left-turn control in use prior to the implementation of the FYA indication. As noted previously, Groups A, B, and C include sites previously controlled with PPLT, protected only, and permissive only left-turn phasing, respectively. The division of intersections within these three groups was justified by the known large variation in change of responsibility placed on the driver in each scenario. Each group was analyzed with respect to three response variables:

- Total crashes;
- Left-turn crashes; and
- FYA approach left-turn crashes.

The third group was expected to be the most appropriate and specific for evaluating the safety impact of the FYA indication; however, the frequency of crashes in this category is the lowest of the three groups limiting the ability to place much significance in the analysis results. Recall that FYA approach crashes include those reported crashes that involved a left-turning vehicle entering the intersection on an approach implemented with the FYA indication. For the

purposes of this study, the left-turn crash category included any crash in which a vehicle was reported as making a left-turn or a U-turn from the left-turn lane.

Task 5 – Report of Findings

At the completion of Task 4, the research team summarized the results of the entire research effort within this report. The report describes the study procedures and results of the research leading to recommendations regarding future use of the FYA permissive indication.

CHAPTER 3 – LITERATURE REVIEW

FYA Literature

Literature pertaining to the FYA permissive indication is comprehensively documented in NCHRP Report 493. Since the publication of NCHRP Report 493 in 2003, research has been conducted to evaluate the potential impacts and applications for the FYA indication. Specifically, evaluation has primarily focused on driver comprehension of the FYA, with respect to the following factors:

- Driver-eye movement and driver information gathering;
- Phased implementation of the FYA signal indication;
- Wide intersection geometry; and,
- Pedestrian and vehicle interaction.

The following sections outline all relevant literature and research efforts since the completion of the NCHRP Report 493.

Driver Eye Movement Evaluation

Although NCHRP Report 493 concluded that the FYA is well comprehended by drivers, knowledge of the sources of information that are most important to permissive left-turning drivers can be used to further improve driver comprehension. Knodler and Noyce researched the eye movements of eleven drivers at six virtual intersections with permissive left-turn phases to identify what driver information is commonly used while executing the maneuver (4). The study resulted in 66 evaluations using the full-scale driving simulator in the Human Performance Laboratory at the University of Massachusetts–Amherst. A detailed visual world was created for drivers to navigate through real-world driving situations. While drivers navigated the virtual roadway environment in the simulator's four-door Saturn Sedan, an ASL Series 5000 eye tracker with head-mounted optics was used to monitor eye movement. The ASL unit converted the eye position to an external point of gaze by superimposing crosshairs on a projected video screen.

The experiment evaluated three permissive indications installed at six intersections, as shown in Figure 7. Opposing vehicles were present at three of the permissive left-turning intersections, and absent at the remaining three intersections. To provide additional experimental variability, drivers were required to complete movements at eight intersections that were not permissive left-turns.

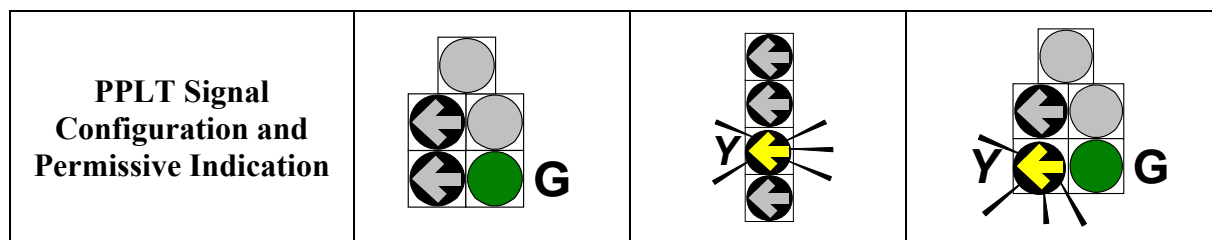

FIGURE 7 Permissive Left-turn Displays Evaluated by Knodler and Noyce (4)

Analysis of the experimental intersections included driver response and driver eye movements. Driver eye movement was found to be most valuable. In order to evaluate driver eye movements, the driver display was partitioned into multiple “areas of interest.” Each area of interest coincided with a potential cue that drivers may use to complete the permissive left-turn. Partitions included the PPLT signal display, the adjacent through signal, the cross traffic, opposing vehicles, and the location where pedestrians may be in the crosswalk to the left of driver. Figure 8 shows the partitions used in the evaluation.

Several of the major trends identified through a limited number of driver eye-movement evaluations included:

- Drivers used more sources for driver information when no opposing vehicles were present;
- The driver's eye primarily “rested” on the opposing traffic;
- Glancing away from the eye resting point, drivers fixated on other sources of information for less than one second at a time; and,
- Drivers scanning multiple sources of information tended to scan from the right side of the intersection to the left.

It was interesting to note that drivers often did not use the traffic signal display and indication as the primary source of left-turn information.

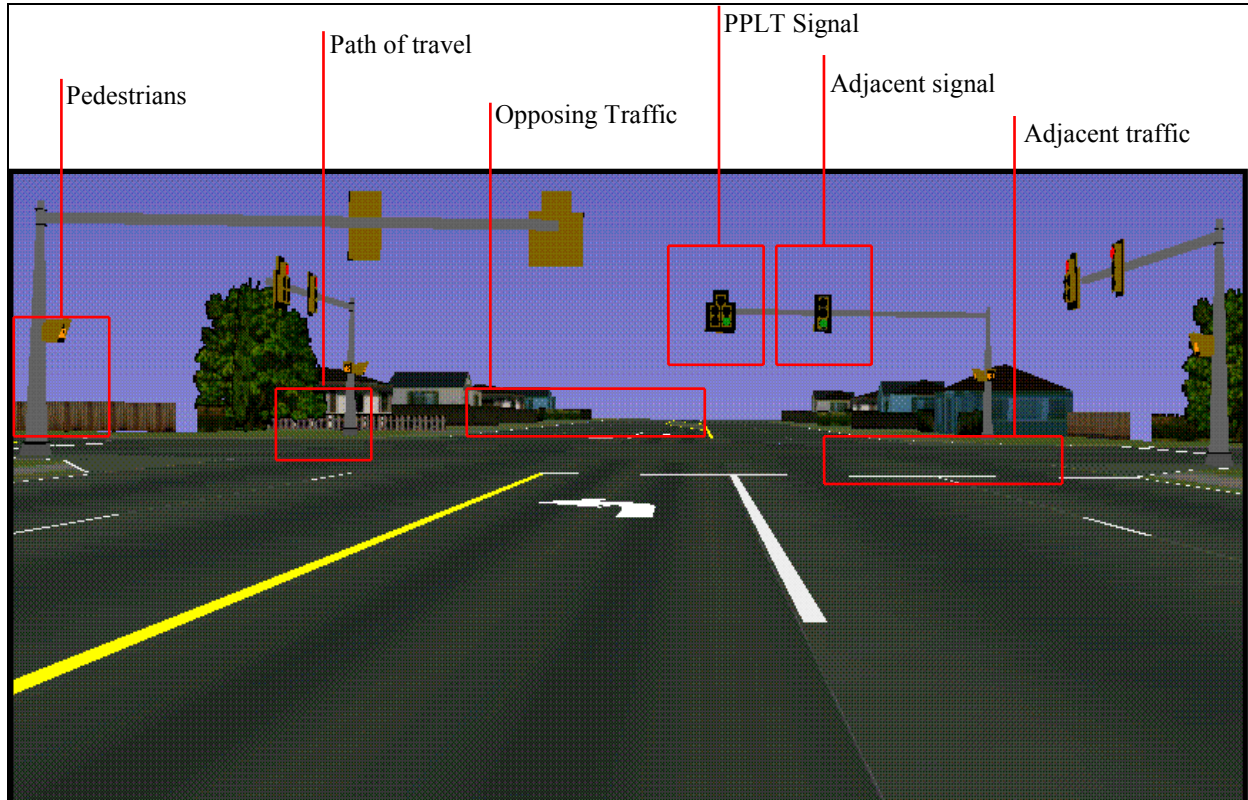

FIGURE 8 Partitioned Driver Simulation Display (4)

Simultaneous Permissive Left-Turn Indications

The PPLT left-turn movement has been displayed in multiple configurations throughout the United States. Requirements outlined in Section 4D.15 of the MUTCD state that “a minimum of two signal faces shall be provided for the major movement on the approach, even if the major movement is a turning movement” (5). A common scenario that meets this requirement is to utilize a five-section cluster signal for the left-turn and through movements, and an adjacent three-section head for through and right-turn movements.

Implementation of the FYA will require an interim retrofit display that will be displayed simultaneously with either a circular green (CG), circular yellow, or circular red indication in the adjacent lanes. Knodler et al. evaluated driver comprehension of the FYA indication when used simultaneously with the adjacent through movement signal indication in a shared five-section cluster signal head (6). Additional research evaluated the simultaneous use of the FYA indication and various adjacent through movement displays. Driver comprehension under various display scenarios was compared. Figure 9 shows the seven signal display scenarios evaluated.

Driver evaluation involved two groups of participants. The first group participated in a dynamic driving simulator and follow-up computer-based static evaluation in Massachusetts. The second group only conducted the static evaluation in Massachusetts or Wisconsin. Using the full-scale driving simulator in the Human Performance Laboratory at the University of Massachusetts–Amherst, experimental drivers completed a test course and two study modules in the simulated environment. Each module included 14 intersections, 8 of which were permissive left-turn movements. Each driver that completed the driver simulator also completed a follow-up computer-based static evaluation that included 29 scenarios. Independent of the driving simulator, a diverse group of 210 drivers completed an independent static evaluation which resulted in a total of 2,310 scenarios evaluated.

Drivers in all evaluations encountered several intersection scenarios and were asked to respond to each dual-display scenario with go, yield, stop, or stop and wait. The responses were classified for evaluation as follows:

- Go. Considered an incorrect response, the driver chose to turn assuming they had right-of-way. A crash or narrowly avoided crash occurred.
- Yield. Considered a correct response, the driver completed a left-turn after yielding to opposing traffic.
- Stop First. A conservative response, the driver stopped at the stop bar prior to completing a left-turn after finding an appropriate gap in opposing through traffic.
- Stop and Wait. The driver waited at the stop bar even after opposing through traffic had cleared the intersection. The driver was considered to be waiting for the signal to change prior to proceeding.







Sc. #	PPLT Signal Indication	Adjacent Through Signal Indication	Sc. #	PPLT Signal Indication	Adjacent Through Signal Indication
1			5		
2			6		
3			7		
4					

FIGURE 9 Signal Display Scenarios Evaluated (6)

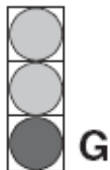
There were no statistically significant differences in the responses across the presented scenarios in the driving simulator. The research did find statistical difference in the distribution of yield responses across the five displays resulting from the follow-up static evaluation. The five-section cluster arrangement displaying an FYA/CG permissive indication had a significantly higher percentage of yield responses than all other displays, except the FYA in a four-section vertical configuration when the adjacent through-movement indication was CG.

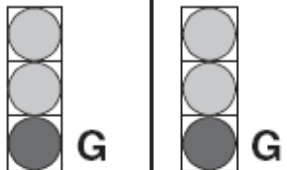
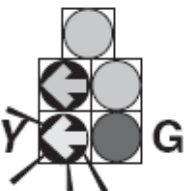
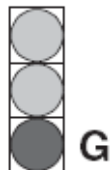
The researchers concluded that the simultaneous display of the FYA and the adjacent through movement indication did not affect drivers' understanding of the permissive indication. Specifically the researchers concluded through a follow-up static evaluation that the retrofit five-section display improved drivers' comprehension of the permissive indication compared to comprehension of the existing circular green (CG) display at a 95-percent level of confidence.

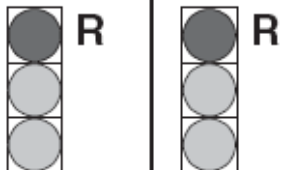
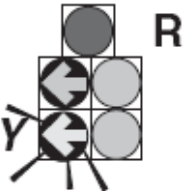
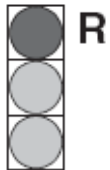
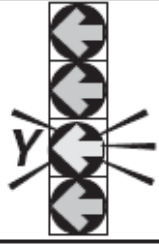
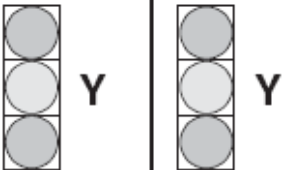
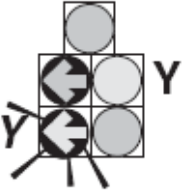
This result along with others determined from the study led researchers to recommend the five-section cluster signal display to be acceptable for interim use while converting signals to the recommended four-section vertical protected/permissive left-turn (PPLT) display.

Two Allowable Permissive Left-Turn Indications

The FYA creates an alternative permissive indication that will result in two acceptable left-turn displays; both intended to indicate the same message to the driver. A logical concern is that driver understanding of the CG PPLT indication will change when an alternative PPLT indication, the FYA, is concurrently installed. For example, when drivers become more familiar with the FYA and identify it as a permissive left-turn indication, it is plausible that the CG indication would be interpreted as a protected left-turn.

Knodler, et al. conducted research using both static evaluations and a dynamic driving simulator to determine driver response to the CG indication after having been exposed to the FYA indication (7). The hypothesis of their research was that “drivers are more likely to interpret the CG permissive indication to indicate a right-of-way situation if the FYA is gradually implemented at a number of intersections and drivers comprehend the FYA indication.”

A total of 25 drivers used a computer-based training program to learn about the FYA indication prior to participating in the driving simulation. The simulation environment included 14 intersections, half of which involved left-turn maneuvers with an FYA indication, a protected green indication, or a CG indication. Drivers were first exposed to the FYA, and then encountered an intersection display with the CG indication that was used for evaluation. The follow-up static evaluation and the independent static evaluation maintained the same consistent approach used in the simulated environment.

The researchers provided statistical evidence that the implementation of the FYA may not impact drivers understanding of the CG indication during a short period after implementation. In fact, the follow-up static evaluation showed that drivers familiar with the FYA responded with a higher percentage of *yield* (correct) responses to the CG indication, compared to those unfamiliar with the FYA. Driver responses in the dynamic driver simulator were shown to be independent of exposure to the FYA indication. The independent static evaluation did not provide any significant findings that have not been discussed in previously cited literature.

Driver Comprehension of Solid Yellow Indication

Traffic engineers have voiced concern about how to effectively terminate a signal phase once the FYA permissive indication is implemented on a broad scale. The concern is based on the fundamental understanding that traditionally when drivers see a yellow indication, it means that a signal phase is being terminated. By implementing the FYA as a second yellow indication that does not imply termination of another phase, driver understanding of the circular yellow (CY) indication may be impacted. Additional concern is related to the identification of an effective way to indicate termination of the FYA permissive phase.

Traditional three-section signal heads include two variables; color and location. Together they provide redundancy in the display shown to drivers. Redundancy improves driver comprehension and minimizes error. Driver error is hypothesized to be increased by a lack of redundancy caused by the use of two subsequent displays using the color yellow; the first being the CY change and the second being the FYA.

Knodler et al. used a computer-based static evaluation to determine the impact that exposure to and comprehension of the FYA indication may have on driver comprehension of the solid yellow arrow (SYA) indication (8). A total of 212 drivers completed sequential evaluations in Madison, Wisconsin and Amherst, Massachusetts. The experiment was sequential in evaluating the SYA before drivers were exposed to the FYA operations. Subsequent evaluation of the SYA after exposure to the FYA was focused on any change in driver response to the SYA. The researchers concluded that there was no evidence to suggest that the FYA permissive indication may negatively affect drivers' understanding of the SYA indication.

Applications of the FYA in Separated Left-Turn Lanes

Intersection geometry is a major factor that has potential to impact the probability that drivers erroneously comprehend the CG permissive left-turn indication and assume they have right-of-way. Wide intersections with left-turn lanes that are separated from the adjacent through and right-turn lanes are one example of geometric design configurations that have this potential. In this scenario multiple jurisdictions have installed a flashing red arrow (FRA) to indicate a permissive left-turn. When the FYA indication was recommended in NCHRP Report 493, this particular geometric configuration was not thoroughly considered. Knodler et al. conducted follow-up research in an effort to identify the effectiveness of the FYA indication compared to the FRA indication at wide intersections with left-turn geometry as described (9).

The evaluation included three components: a dynamic driving simulator experiment, a follow-up static evaluation, and an independent static evaluation. Four permissive signal displays were evaluated, as shown in Figure 10. The research was conducted in Massachusetts and Wisconsin, both states that use the CG for permissive left-turns and protected-only left-turn phasing at wide intersections. Therefore, it was assumed that participants were unfamiliar with the FYA and the FRA permissive indications.

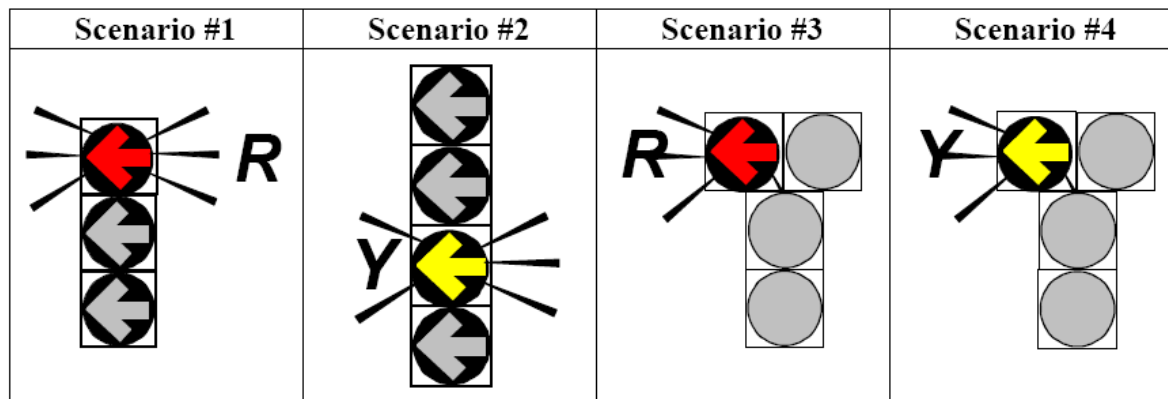

FIGURE 10 Permissive Displays Evaluated at Wide Median Applications (9)

The results of this research can be summarized as follows:

- In the driving simulator a total of ten fail-critical (go) responses were observed at the two scenarios with FYA permissive indications. However, all but one of these responses occurred on the first observation of a FYA display by each driver. Alternatively, no fail-critical responses were observed at the FRA scenarios. These results were statistically significant.
- In the follow-up static evaluation there was no statistically significant difference between the correct response for the FYA and the FRA scenarios. The yield response occurred for the FYA in a similar proportion to the stop first response to the FRA.
- In the independent static evaluation there was a statistically significant higher percentage of go responses for the FYA scenarios than the FRA scenarios. Alternatively, there was also a statistically higher percentage of stop and wait responses to the FRA scenarios than the FYA scenarios.

At wide intersections where the left-turn lanes are separated from the through and right-turn lanes, and the left-turn driver cannot see the through movement indication, the FRA requires the driver to stop before proceeding significantly reducing left-turn capacity. However, it was recommended that the FYA not be installed until it becomes widely implemented and more drivers are familiar with the indication. At wide intersections where protected-only left-turn phasing is not desirable, the use of the FYA or FRA permissive indications may be used.

Driver and Pedestrian Comprehension of Requirements for Permissive Left-Turns

In order to provide effective traffic operations, pedestrian phases are commonly operated with the parallel traffic movement. This phasing leads to conflict when a permissive left-turn is run concurrently with the pedestrian movement parallel to the through traffic. To address this concern, Knodler, et al. conducted evaluations of driver and pedestrian comprehension of operational requirements of permissive left-turn applications (10). Both static and dynamic evaluations were administered to understand comprehension of the FYA from pedestrian and driver perspectives.

A dynamic driving simulator evaluation was administered to consider driver comprehension of the need to yield to pedestrians in addition to oncoming vehicles. Five signal display scenarios, as shown in Figure 11 were evaluated by 36 drivers. Several factors were varied within the driving simulator, including: presence or absence of pedestrians crossing the intersection; 3-leg or 4-leg intersection geometry; and, driver maneuver made at the intersection (straight, right-turn, left-turn).

An additional 103 participants completed the static evaluation, which resulted in a total of 139 driver evaluations of the static displays. Each driver completed 25 scenarios in the static evaluation which included an additional variable not evaluated in the dynamic simulator. The type of pedestrian varied among no pedestrian, a pedestrian waiting to cross, and a visually impaired pedestrian (with dog guide) waiting to cross. An example scenario from the computer-based static survey is shown in Figure 12.

Sc #	Standard (4 – Leg) Intersections		Sc #	“T” (3 – Leg) Intersections	
	PPLT Signal Indication	Through Signal Indication		Signal Display	
1			4		
2			5		
3			<p><i>Notes: At the standard (4-Leg) intersections - the five-section cluster signal heads were located in a shared location over the lane line between the left-turn and adjacent through lanes. The four-section vertical configuration was centered over the left-turn lane.</i></p>		

FIGURE 11 Permissive Scenarios Evaluated in Driving Simulator (10)

Pedestrian comprehension of the FYA indication was evaluated by a computer-based static evaluation. The evaluation presented the user with a pedestrian-crossing situation and the user was asked how they would respond under the given conditions. Seven permissive left-turn signal displays were evaluated, with and without a pedestrian signal present, to determine pedestrian comprehension of appropriate crossing opportunities. The evaluation also presented combinations of signal indications including CR, CY, SYA, and variations with pedestrian signal head scenarios.

The researchers comprehensively found that the study supports the use of the FYA as a safe and effective device for left-turn traffic. Additional conclusions are summarized below:

Driver Simulation

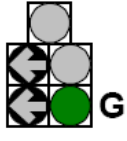
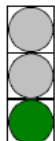
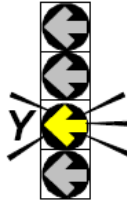
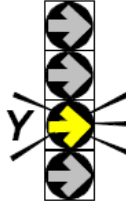
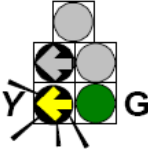
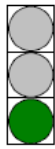
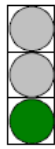
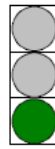
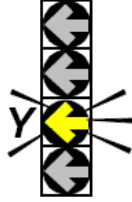
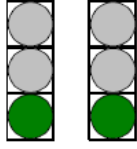
- Drivers exhibited low comprehension of the requirement to yield to pedestrians legally within the crosswalk. This was determined by combining the results of each permissive scenario evaluated by 36 drivers to find that the percentage of *yield* (correct) responses was lower than the percentage of fail-safe responses.

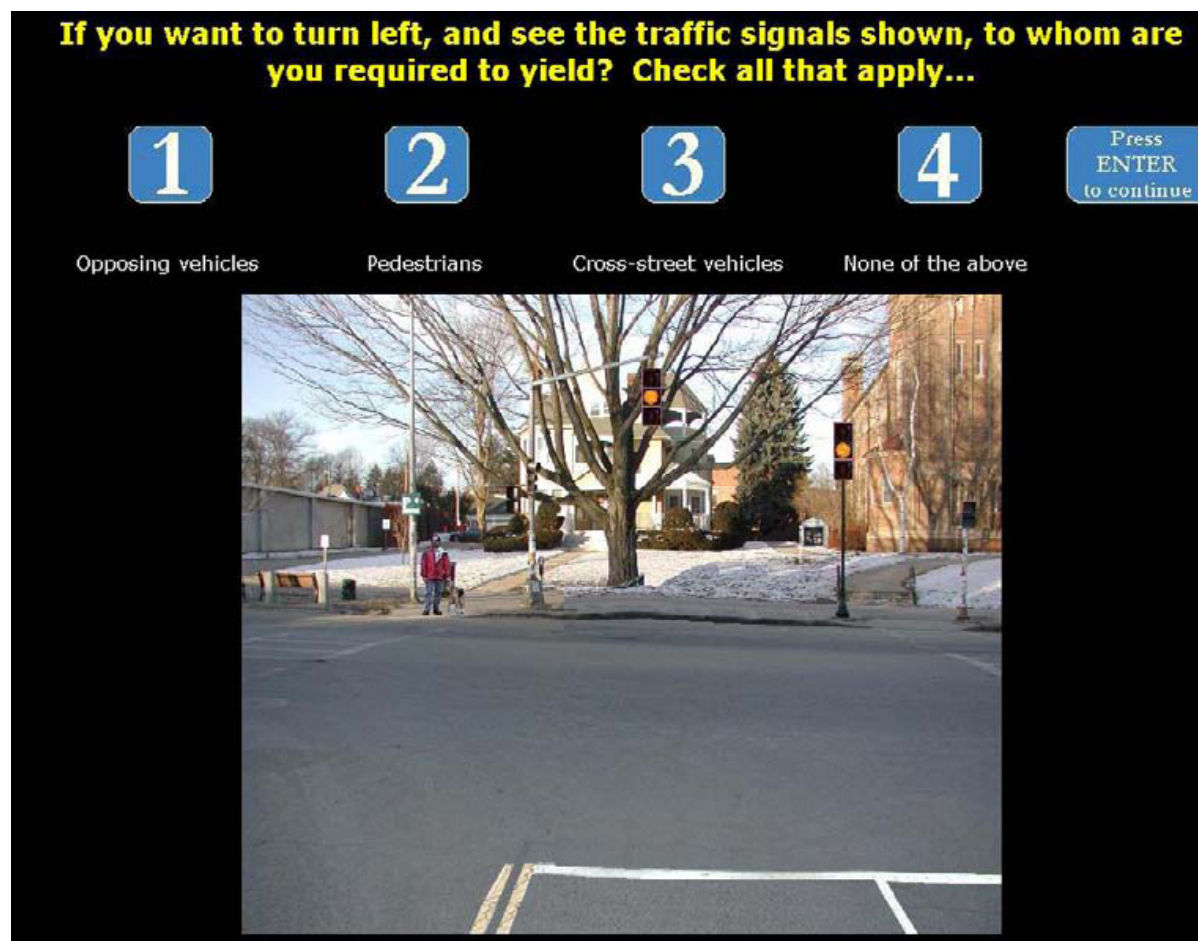

FIGURE 12 Sample Scenario of Computer-based Static Evaluation (10)

Static Driver Evaluation

- At a “T” intersection, drivers were statistically more likely to respond correctly to the FYA scenario than the CG scenario. Drivers observing the FYA were statistically more likely to respond with a yield (correct) or stop and wait (fail-safe) response than the standard three-section head with a CG display. The CG display scenario was statistically more likely to result in a driver response of go (incorrect).

Static Pedestrian Evaluation

- Less than half of the participants in the static evaluation of pedestrian comprehension understood correct crossing procedures.
- When no pedestrian signal heads were available, pedestrians correctly identified crossing opportunities more often when viewing the CG signal display scenario than the FYA display.

Experimentation with Three-Section Signal Displays

Jackson County, Oregon has experimented with the FYA indication since 2001. The county's experience with the FYA indication has been summarized and presented to multiple audiences, including the 2005 ITE Annual Meeting in Melbourne, Australia (12).

The county analyzed delay benefits associated with conversion of five signalized intersections from protected-only left-turn phasing to PPLT phasing with the FYA indication (12). Using signal analysis software, peak-hour vehicle delay associated with each left-turn phasing scheme was calculated. Necessary analysis assumptions included:

- One hour of delay is valued at \$20 during the peak period of the day;
- The peak hour contains ten percent of the daily volume; and,
- The delay reduction in the PM peak hour occurred during each day in the study period.

Estimated benefit-to-cost ratios for each intersection were developed based on these assumptions and estimates of crash costs. Crash costs were estimated to be \$40,000 for injury crashes and \$10,000 for PDO crashes. A 2000 study prepared by the National Highway Traffic Safety Administration reported the economic cost of crashes of varied severity (13). In comparison to those used in this analysis, NHTSA estimated costs that are significantly higher than those used by Jackson County. The economic costs estimated by NHTSA range from \$10,000 and \$1,100,000 for injury crashes and \$2,500 for property damage only. The results of this analysis are shown in Table 3.

TABLE 3 Benefit and Cost Analysis Data (12)

	Table Rock & Vilas	Table Rock & Biddle Road	Table Rock & Antelope	Main & Lozier	Pine & Peninger
Previous Left-turn Phasing	Protected	Protected	Protected	Protected	Protected
Date Converted to FYA	5/14/2001	7/9/2001	7/13/2001	4/18/2002	5/21/2002
Days prior/after change	961	905	901	622	589
Study Period (Yrs)	2.6	2.5	2.5	1.7	1.6
Date Study Started	9/26/1998	1/16/1999	1/24/1999	8/4/2000	10/9/2000
Left Turn Crashes Prior	0	0	0	0	0
Left Turn Crashes After	1	2	3	6	1
Left Turn Crashes - First 6 Months	0	1	1	6	0
Injury	0	1	2	3	1
PDO	1	1	1	3	0
Protected Average Delay (sec/veh)	34.6	56.2	16.2	26.2	11.9
Protected-Permissive Average Delay (sec/veh)	21.1	54.2	9.2	15.9	10.5
Delay Reduction (sec/veh)	13.5	2	7	10.3	1.4
PM Peak Hour Entering Volume	2348	2037	1506	2085	2450
Peak Hour Delay Reduction (veh-hr)	8.8	1.1	2.9	6	1
Peak Hour Benefit at \$20/hour	\$176	\$23	\$59	\$119	\$19
Daily Benefit	\$1,761	\$226	\$586	\$1,193	\$191
Delay Benefit for Study Period	\$1,692,321	\$204,832	\$527,686	\$742,098	\$112,237
Estimated Crash Cost	\$10,000	\$50,000	\$90,000	\$150,000	\$40,000
Benefit/Cost Ratio	169.2	4.1	5.9	4.9	2.8

The analysis found that the benefit-to-cost ratios supported the implementation of the FYA indication. The benefit-to-cost ratios would decrease if the NHTSA crash costs were used to analyze those intersections where injury crashes occurred.

The county also reported on the success of converting a five-section “doghouse” display to a four-section exclusive left-turn display at the Pine Street/Hamrick Road intersection. Success was measured by a simple before and after comparison of crashes and public response. There were 19 crashes reported in the 2.7-year period prior to the conversion from the doghouse to the FYA PPLT display. In the 2.7 years after conversion there were 8 crashes reported.

Twice as many positive public comments were received compared to negative, in response to the FYA implementation at the Pine Street/Hamrick Road intersection and other intersections in Jackson County where the FYA had been implemented.

Literature Review Summary

Multiple studies included in this literature review have evaluated driver comprehension of the FYA under various conditions. Many made use of a full-scale driving simulator or computer-based static evaluations. Key findings from the studies in this literature review include:

- Drivers are expected to successfully comprehend the FYA indication while it is being implemented.
 - Driver comprehension of the FYA permissive indication remains high.
 - There is no evidence from driver studies that suggests use of the FYA will reduce comprehension of the CYA indication in use as a clearance interval.
 - The use of the FYA is not expected to reduce driver comprehension of the CG indication in use as a permitted phase at neighboring intersections. Use of the FYA may improve comprehension of the CG indication.
- Major geometric features influence driver comprehension of the FYA display.
 - The use of permissive left-turn phasing at intersections with wide medians should be considered only after the FYA indication has been widely used and drivers have become more familiar.
 - Drivers were statistically more likely to respond correctly to the FYA scenario than the CG scenario at “T” intersections.

CHAPTER 4 – FINDINGS & APPLICATIONS

Research Results

This chapter provides a summary of the data, evaluation, and research results. Given that the acquisition of data was the most critical component of this research effort, this chapter begins with a discussion of data availability.

Data Availability

After the FYA display achieved interim approval (IA) status from FHWA on March 20, 2006, it was not possible to track all installations of the FYA due to the increased frequency of installation and the lack of specific location information of each site. It was further recognized that most agencies were not collecting any data for new sites implemented after that date, nor would any data that was collected include a sufficient after period duration. Therefore, data included in this study primarily included sites implemented before the FYA display achieved IA status from FHWA. The data collected were further limited by the number of sites for which at least one year of crash data was available after implementation. Table 4 summarizes the locations of experimental sites approved by FHWA prior to the IA, and the initial sources of data included in this research.

Of the 201 sites approved for experimentation with the FYA display, approximately 120 had been installed as of August 2006. Some amount of data was obtained from the corresponding transportation agencies for 104 of the 120 sites. The implementation history and type of left-turn control operating prior to the FYA installation at each of the 104 sites is shown in Figure 13.

The majority of experimental sites were installed in 2005 and 2006. Typically, an evaluation of the impact of a change in traffic control excludes a period of time immediately after the change was implemented to account for the so-called ‘novelty effect’. This period is not considered to be a reflection of the long-term operations or safety. Therefore, only those sites for which one year or more of post-implementation data was available were considered for further analysis in an effort to develop a dataset that includes typical crash patterns over an extended period of time. The limitation in ‘after’ data further limited the available study intersections, as only 50 of the 104 implementation intersections/sites for which data was provided had at least one year of post-implementation crash data. Table 5 provides a summary of these locations.

Study Sites

Figures 14 through 16 provide an overview of the general characteristics of the study sites selected. Note that three of the 50 locations were divided into two sites because of the characteristics of the installations/intersections resulting in 53 sites. Figure 14 shows the number of sites that were operating with each type of left-turn phasing. Twenty-seven sites were converted from protected-only left-turn phasing to PPLT with the FYA indication, 21 sites from PPLT, and only five sites were converted from permissive only left-turn control. Only five sites converted from permissive only limited the ability to complete a detailed analysis of those sites.

TABLE 4 Summary of FYA Experimental Data

State	Jurisdiction	FHWA Approved Experimental Sites	Confirmed Experimental Installations ¹	Site Data Received
AZ	Tucson	3	0	0
CA	El Cajon	2	1	1
	Fullerton	7	4	4
	Pasadena	3	2	0
CO	Boulder	2	2	2
FL	Broward Co.	5	3	3
ID	Coeur d' Alene	1	1	0
	ITD	1	0	0
	Nampa	8	2	2
	Pocatello	18	13	13
MD	Montgomery Co.	3	3	3
MI	Livingston	5	4	4
	Oakland Co.	6	6	6
MN	MN/DOT	1	1	0
NC	Charlotte	1	1	0
	NCDOT	8	3	3
NV	Sparks	6	0	0
OR	Albany	1	1	0
	Beaverton	22	16	16
	Bend	5	5	0
	Central Point	1	0	0
	Clackamas Co.	4	0	0
	Gresham	6	6	6
	Jackson County	7	7	7
	Milwaukie	1	1	0
	ODOT	29	17	16
	Oregon City	1	1	1
	Portland	3	1	1
	Tualatin	4	1	1
	Washington Co.	2	Unconfirmed	
TX	Irving	3	3	0
VA	Alexandria	4	2	2
WA	Kennewick	9	4	4
	Lacey	1	1	1
	Snohomish County	12	6	6
	Marysville	2	0	0
	Vancouver	2	0	0
WY	Cheyenne	2	2	2
Total		201	120	104

¹ Although sites were approved for the installation of the FYA, not all were implemented at the time of this research.

TABLE 5 Summary of FYA Experimental Data – One Year of After Data

State	Jurisdiction	FHWA Approved Experimental Sites	Confirmed Experimental Installations ¹	Sites With 1 Year After Crash Data
CA	El Cajon	2	1	1
	Fullerton	7	4	4
CO	Boulder	2	2	1
FL	Broward Co.	5	3	1
	Nampa	8	2	2
MI	Livingston	5	4	4
NC	NCDOT	8	3	2
OR	Beaverton	22	16	5
	Jackson County	7	7	7
	ODOT	29	17	10
VA	Alexandria	4	2	2
WA	Kennewick	9	4	3
	Lacey	1	1	1
	Snohomish County	12	6	5
WY	Cheyenne	2	2	2
Total		123	74	50

¹ Although sites were approved for the installation of the FYA, not all were implemented at the time of this research

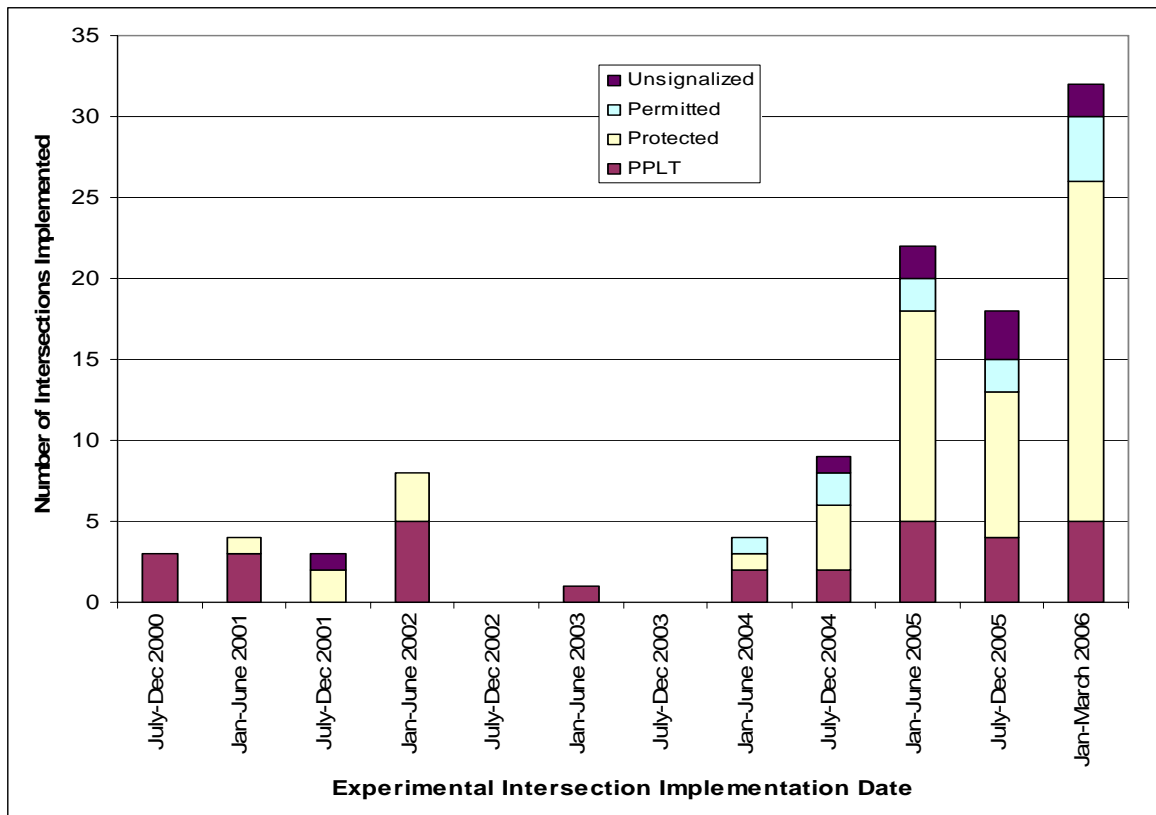

FIGURE 13 FYA Experimental Intersection Implementation Dates for 104 Intersections

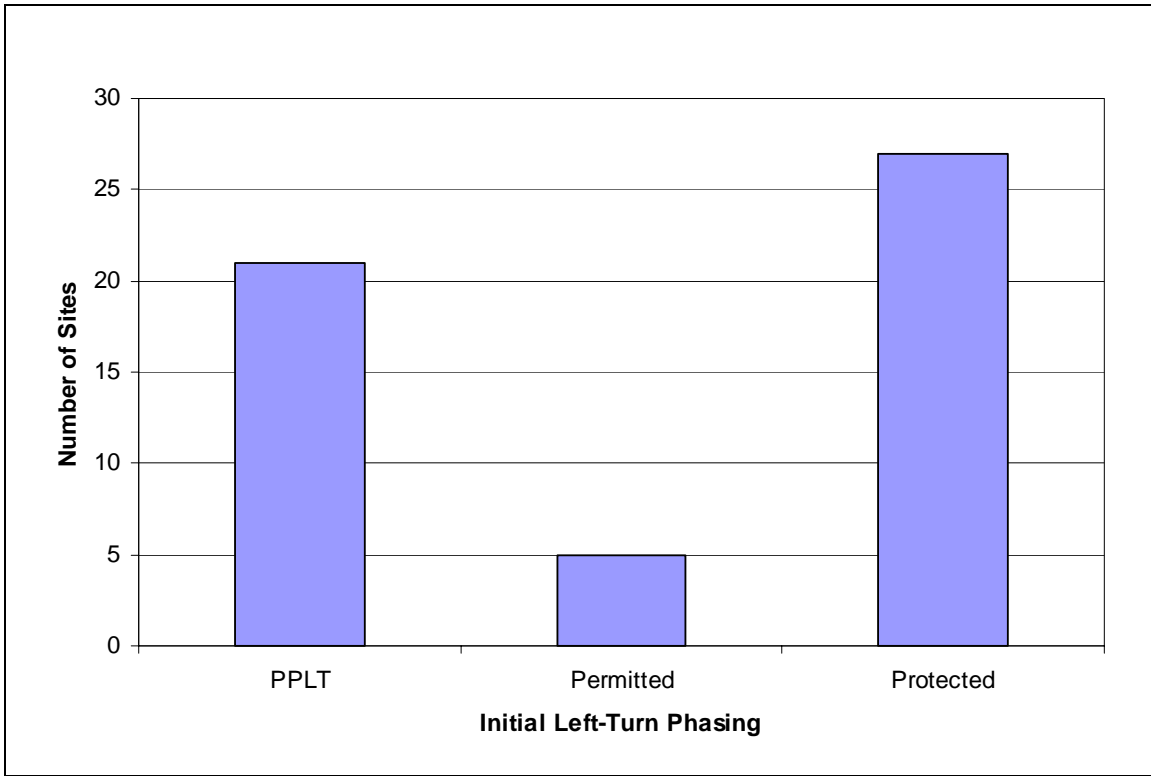

FIGURE 14 Left-Turn Control Prior to Implementation of the PPLT FYA Display

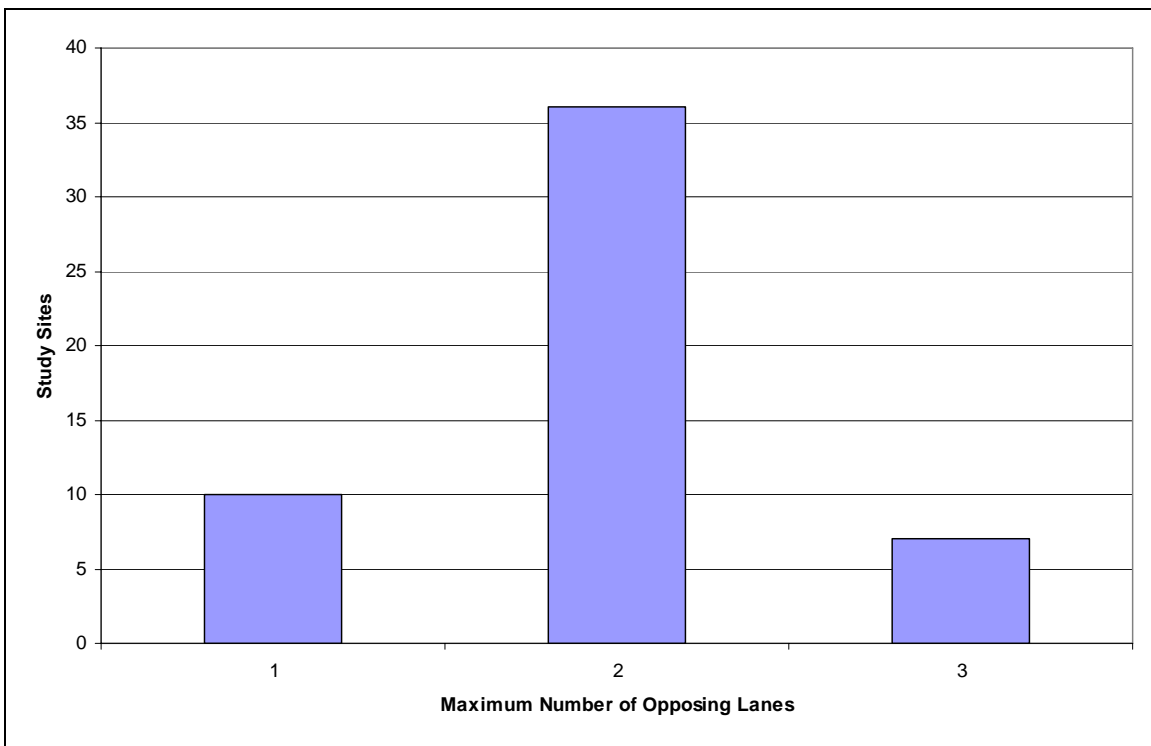

FIGURE 15 Average Number of Through Lanes Opposing FYA Left-turn Approach

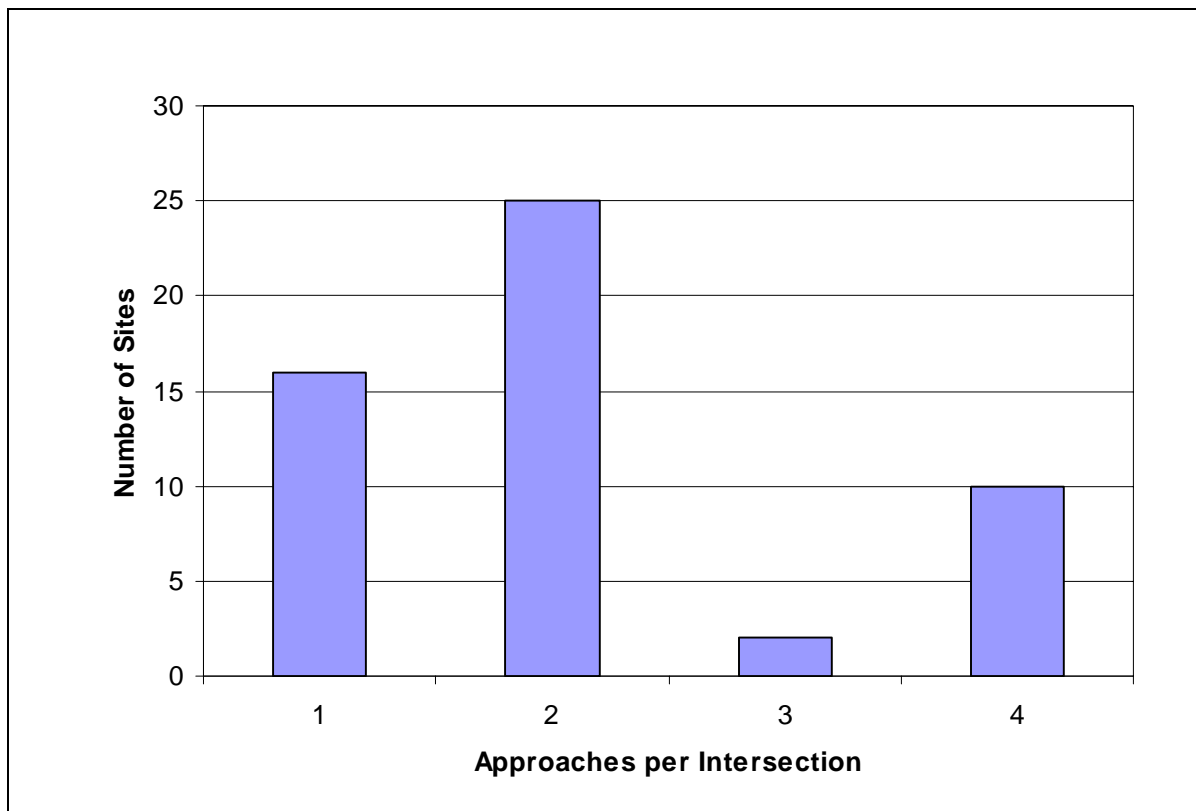

FIGURE 16 Number of Intersection Approaches Implemented with the FYA Display

Several locations were converted from unsignalized control to PPLT signal control with FYA. These intersections were not included in further analysis due to the significant traffic control changes.

Figure 15 shows a summary of the number of lanes opposing the left-turns implemented with the FYA indication by site. The maximum number of opposing through lanes is reported, which considers those sites where the FYA left-turn movement opposes a different number of lanes in each direction. An example would be when an FYA is implemented in both directions on a major street with two through lane in one direction and three through lanes in the opposite direction. Such cases were limited in the study dataset. The FYA indication was most often implemented on an approach with two through lanes opposing the left-turn movement. The study included intersections with one, two, or three through lanes opposing the FYA left-turn movements.

Figure 16 summarizes the number of approaches to each intersection that were implemented with a FYA display. Nearly 50 percent of study intersections had an FYA indication installed on two approaches. For intersections with an FYA indication on only one approach, the majority of those intersections were three-legged ('T') intersections, but the study dataset also included some four-leg intersections where only one approach was implemented with an FYA display.

Sign Test Results

Given the wide array of differing variables at each of the intersections in the data set, the first set of analyses focused on the individual results observed at each intersection. A relatively simple statistical evaluation was conducted to determine the number of study intersections where the average annual frequency of crashes increased or decreased after implementation of the FYA indication. A ‘sign test’, associating a positive sign (crash increase) or negative sign (crash decrease) was associated with each location. Evaluation of total crash frequency, left-turn crash frequency, and FYA left-turn crash frequency was completed for three groups of implementation sites. Tables 6 through 8 present the findings of the site analysis for before conditions of protected/permissive (Group A), protected (Group B), and permissive only (Group C) left-turn control. Note that the number of sites was further reduced to 35 to include only those in which sufficient data was available to complete the analysis.

Analysis of total and left-turn crashes resulted in similar findings. As shown in Table 6, 12 of 13 Group A sites showed a reduction in average annual crashes after implementing the FYA indication. Only 6 of 18 Group B sites and two of four Group C sites observed crash reductions. Considering Table 7, a reduction of left-turn crashes occurred after implementation at all sites within Group A. Analysis of Group B sites showed that the average annual crash frequency of left-turn related crashes increased at all but two sites. One site within Group C showed an increase in the frequency of crashes, the others decreased.

Table 8 identifies those left-turn crashes that are known to have involved a vehicle making a left-turn from an approach where a FYA display was planned in the before period, or installed in the after period. Table 8 shows that the average annual crash frequency was reduced or stayed the same after implementation of the FYA display at all sites in Group A that had detailed crash data. Conversely, average annual crash frequency increased after implementation of the FYA display at those sites within Group B. No crashes were reported in the period after implementation at Group C sites.

Figure 17 provides a graphical summary of the results of the sign test conducted for both total crash frequency and left-turn crash frequency. Sign test results indicate that the total and left-turn crash frequency was reduced at nearly all sites in Group A. To determine whether a decrease was more likely for the Group A sites, the following hypothesis was considered:

$$H_0: p = 0.50$$

$$H_a: p \neq 0.50$$

Equation 1 represents the probability mass function of the binomial distribution:

$$b(x; n, p) = \binom{n}{x} p^x (1 - p)^{n-x} \quad (1)$$

Table 9 provides the computation results of Group A study sites for multiple crash levels.

TABLE 6 Sign Test Results for Evaluation of Total Crashes

ID	Intersection Name	Months of Crash Data (Before/ After)	Average Annual Crashes Before FYA	Average Annual Crashes After FYA	Change
Group A: Protected/Permissive Left-Turn Control					
43	US 117 (S. College Rd.)/Big K	60/12	11.4	8.0	-
45	125th Avenue/Longhorn Drive	36/55	1.3	0.4	-
49	Allen Boulevard/Menlo Drive	36/48	4.0	3.0	-
50	Allen Boulevard/Wilson Avenue	36/48	2.7	1.5	-
67	Pine(Biddle Road)/Hamrick	60/60	9.4	3.6	-
81	ORE 10/White Pine	48/18	2.3	0.7	-
85	ORE 99E/ Hardcastle Street	24/54	5.5	3.1	-
86	ORE 99E/ Lincoln Street	24/48	2.5	1.0	-
92	Duke Street/ 4600/ Fox Chase	36/24	6.3	4.0	-
93	Duke Street/ Jordan Street	36/24	5.7	3.0	-
98	Mullen Road/ Ruddell Road	36/24	8.0	5.0	-
100	128th St. SW/ 5th Place West	60/17	8.4	9.2	+
101	164th St SE/ 9th Ave/Main/Mill	22/21	18.5	15.4	-
Group B: Converted from Protected Left-Turn Control					
1	Magnolia Avenue/Park Avenue	36/12	3.3	7.0	+
4	Orangethorpe Ave./Lemon St.	60/19	3.2	6.9	+
28	Brighton Rd./Brighton H.S. Entrance	60/24	2.0	1.5	-
29	Old US-23/Spencer Rd E	60/24	8.2	6.0	-
30	Old US-23/Spencer Rd W	60/24	11.8	7.5	-
58	Hall Boulevard/Nimbus Avenue	60/18	6.4	4.7	-
66	Main/Lozier Lane	60/48	2.6	2.8	+
69	Pine/NB I-5 Ramp	72/24	1.0	4.0	+
70	Pine/SB I-5 Ramp	72/24	0.8	3.0	+
72	Table Rock/Antelope	60/60	1.0	2.0	+
73	Table Rock/Biddle Road	60/48	3.4	4.8	+
75	ORE 10/107 th	60/19	3.2	7.6	+
76	ORE 10/110 th	60/20	3.4	6.0	+
78	ORE 10/91 st	60/19	3.8	7.0	+
79	ORE 10/Laurelwood	60/19	13.9	5.0	-
80	ORE 10/Western	60/19	3.2	3.2	-
103	Airport Road/ Admiralty Way	60/12	9.0	11.0	+
104	Airport Road/ Gibson Road	60/12	6.4	10.0	+
Group C: Converted from Permissive Only Left-Turn Control					
7	Table Mesa Drive/Tantra Drive	36/27	10.7	3.6	-
53	Beaverton-Hillsdale Highway/Griffith Drive	60/24	5.6	6.5	+
82	N. Hayden Island Drive/Center Street	60/17	3.2	1.4	-
87	US 26/ORE 211	60/16	1.4	1.5	+

TABLE 7 Sign Test Results for Evaluation of Left-Turn Crashes

ID	Intersection Name	Months of Crash Data (Before/ After)	Average Annual Left-Turn Crashes Before FYA	Average Annual Left-Turn Crashes After FYA	Change
Group A: Protected/Permitted Left-Turn Control					
43	US 117 (S. College Rd.)/Big K	60/12	9.2	2.0	-
45	125th Avenue/Longhorn Drive	36/55	1.0	0.0	-
49	Allen Boulevard/Menlo Drive	36/48	2.0	1.0	-
50	Allen Boulevard/Wilson Avenue	36/48	0.3	0.3	-
67	Pine(Biddle Road)/Hamrick	60/60	6.6	2.6	-
81	ORE 10/White Pine	48/18	1.3	0.0	-
85	ORE 99E/ Hardcastle Street	24/54	1.0	0.2	-
86	ORE 99E/ Lincoln Street	24/48	1.0	0.3	-
92	Duke Street/ 4600/ Fox Chase	36/24	1.3	1.0	-
93	Duke Street/ Jordan Street	36/24	0.3	0.0	-
98	Mullen Road/ Ruddell Road	36/24	4.0	1.5	-
100	128th St. SW/ 5th Place West	22/21	4.2	2.8	-
101	164th St SE/ 9th Ave/Main/Mill	60/17	15.3	10.3	-
Group B: Converted from Protected Left-Turn Control					
1	Magnolia Avenue/Park Avenue	36/12	0.7	3.0	+
4	Orangethorpe Ave./Lemon St.	60/19	1.0	3.8	+
28	Brighton Rd./Brighton H.S. Entrance	60/24	0.0	0.0	+/-
29	Old US-23/Spencer Rd E	60/24	0.0	0.0	+/-
30	Old US-23/Spencer Rd W	60/24	1.6	0.0	-
58	Hall Boulevard/Nimbus Avenue	60/18	2.2	1.3	-
66	Main/Lozier Lane	60/48	0.0	1.5	+
69	Pine/NB I-5 Ramp	72/24	0.2	1.0	+
70	Pine/SB I-5 Ramp	72/24	0.0	1.0	+
72	Table Rock/Antelope	60/60	0.0	1.0	+
73	Table Rock/Biddle Road	60/48	0.2	0.8	+
75	ORE 10/107 th	60/19	1.2	3.8	+
76	ORE 10/110 th	60/20	0.2	3.0	+
78	ORE 10/91 st	60/19	0.2	2.5	+
79	ORE 10/Laurelwood	60/19	1.8	1.9	+
80	ORE 10/Western	60/19	0.4	1.3	+
103	Airport Road/ Admiralty Way	60/12	0.6	1.0	+
104	Airport Road/ Gibson Road	60/12	1.0	7.0	+
Group C: Converted from Permissive only Left-Turn Control					
7	Table Mesa Drive/Tantra Drive	36/27	0.4	0.0	-
53	Beaverton-Hillsdale Hwy./Griffith Dr.	60/24	0.2	0.5	+
82	N. Hayden Island Drive/Center St.	60/17	2.0	0.7	-
87	US 26/ORE 211	60/16	0.2	0.0	-

TABLE 8 Sign Test Results for Evaluation of FYA Left-Turn Crashes

ID	Intersection Name	Months of Crash Data (Before/ After)	Average Annual FYA LT Crashes Before FYA	Average Annual FYA LT Crashes After FYA	Change
Group A: Protected/Permitted Left-Turn Control					
43	US 117 (S. College Rd.)/Big K	60/12	9.2	0.0	-
45	125th Avenue/Longhorn Drive	36/55	1.0	0.0	-
49	Allen Boulevard/Menlo Drive	36/48	2.0	1.0	-
50	Allen Boulevard/Wilson Avenue	36/48	0.3	0.0	-
67	Pine(Biddle Road)/Hamrick	60/60	0.8	0.0	-
81	ORE 10/White Pine	48/18	0.8	0.0	-
85	ORE 99E/ Hardcastle Street	24/54	0.5	0.2	-
86	ORE 99E/ Lincoln Street	24/48	1.0	0.3	-
92	Duke Street/ 4600/ Fox Chase	36/24	1.3	1.0	-
93	Duke Street/ Jordan Street	36/24	0.0	0.0	0
98	Mullen Road/ Ruddell Road	36/24	4.0	1.5	-
100	128th St. SW/ 5th Place West	22/21	4.2	2.8	-
101	164th St SE/ 9th Ave/Main/Mill	60/17	-	-	0
Group B: Converted from Protected Left-Turn Control					
1	Magnolia Avenue/Park Avenue	36/12	0.3	2.0	+
4	Orangethorpe Avenue/Lemon Street	60/19	0.0	2.5	+
28	Brighton Rd./Brighton H.S. Entrance	60/24	-	-	0
29	Old US-23/Spencer Rd E	60/24	-	-	0
30	Old US-23/Spencer Rd W	60/24	-	-	0
58	Hall Boulevard/Nimbus Avenue	60/18	0.6	0.7	+
66	Main Street/Lozier Lane	60/48	0.0	1.5	+
69	Pine Street/NB I-5 Ramp	72/24	0.0	0.0	0
70	Pine Street/SB I-5 Ramp	72/24	0.0	0.5	+
72	Table Rock/Antelope	60/60	0.0	1.0	+
73	Table Rock/Biddle Road	60/48	0.2	0.8	+
75	ORE 10/107 th	60/19	0.0	3.2	+
76	ORE 10/110 th	60/20	0.0	3.0	+
78	ORE 10/91 st	60/19	0.0	2.0	+
79	ORE 10/Laurelwood	60/19	2.5	3.0	+
80	ORE 10/Western	60/19	0.4	1.3	+
103	Airport Road/ Admiralty Way	60/12	0.2	0.0	-
104	Airport Road/ Gibson Road	60/12	0.6	3.0	+
Group C: Converted from Permissive only Left-Turn Control					
7	Table Mesa Drive/Tantra Drive	36/27	0.4	0.0	-
53	Beaverton-Hillsdale Hwy./Griffith Dr.	60/24	0.2	0.0	-
82	N. Hayden Island Dr./Center St.	60/17	0.0	0.0	0
87	US 26/ORE 211	60/16	0.2	0.0	-

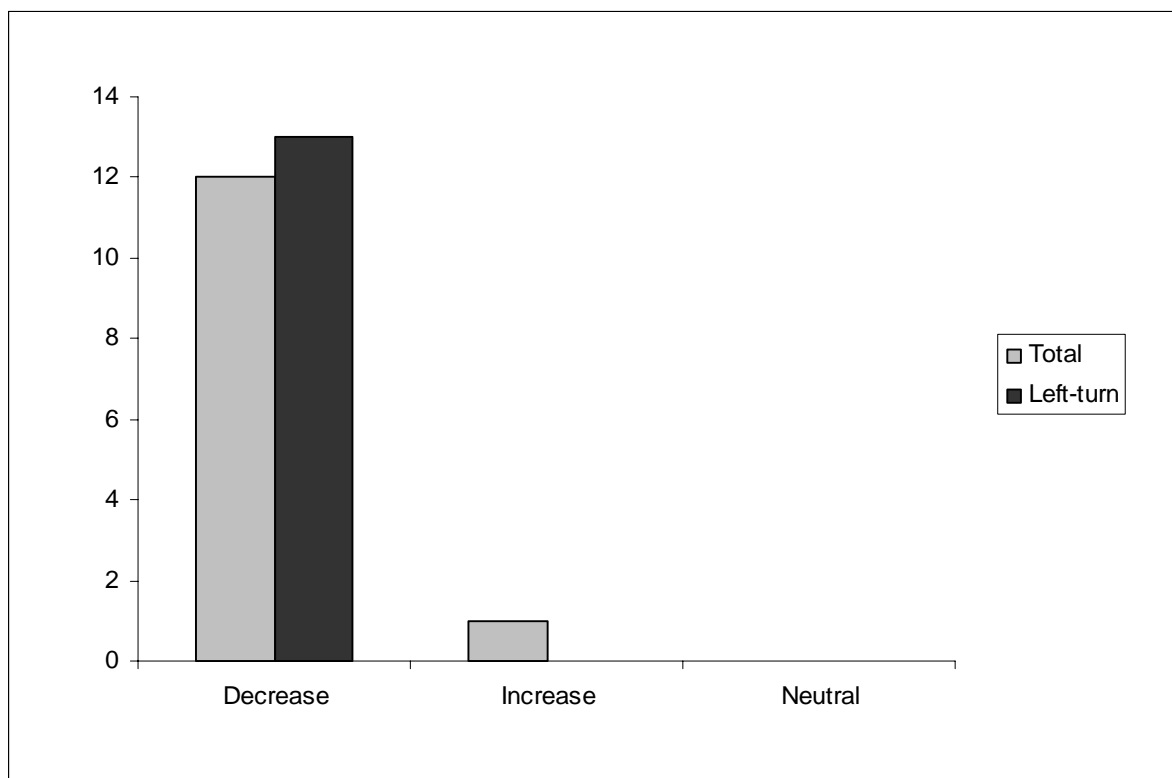

FIGURE 17 Group A Sign Test Results for Total Crashes and Left-turn Crashes

TABLE 9 Binomial Test Results for Group A

Crash Level	Variable			Binomial Test Results	
	X	N	P	B(x; n, p)	Two-tailed Test
Total	12	13	0.5	0.002	0.003
Left-turn	13	13	0.5	0.000	0.000
FYA Left-turn	11	11	0.5	0.001	0.001

As shown in Table 9, there is statistical evidence to suggest that the study sites have decreased in crash frequency after the installation of the FYA indication.

Figure 18 provides a graphical summary of the results of the sign test conducted for both total crash frequency and left-turn crash frequency of Group B sites. The majority of Group B sites showed an increase in crashes after implementation of the FYA display. The following equation represents the probability mass function of the binomial distribution for Group B sites, given the null hypothesis of $p = 0.50$:

$$b(x; n, 0.50) = \binom{n}{x} 0.50^x (0.50)^{n-x} \tag{2}$$

Table 10 provides the computation results of Group B study sites for multiple crash levels.

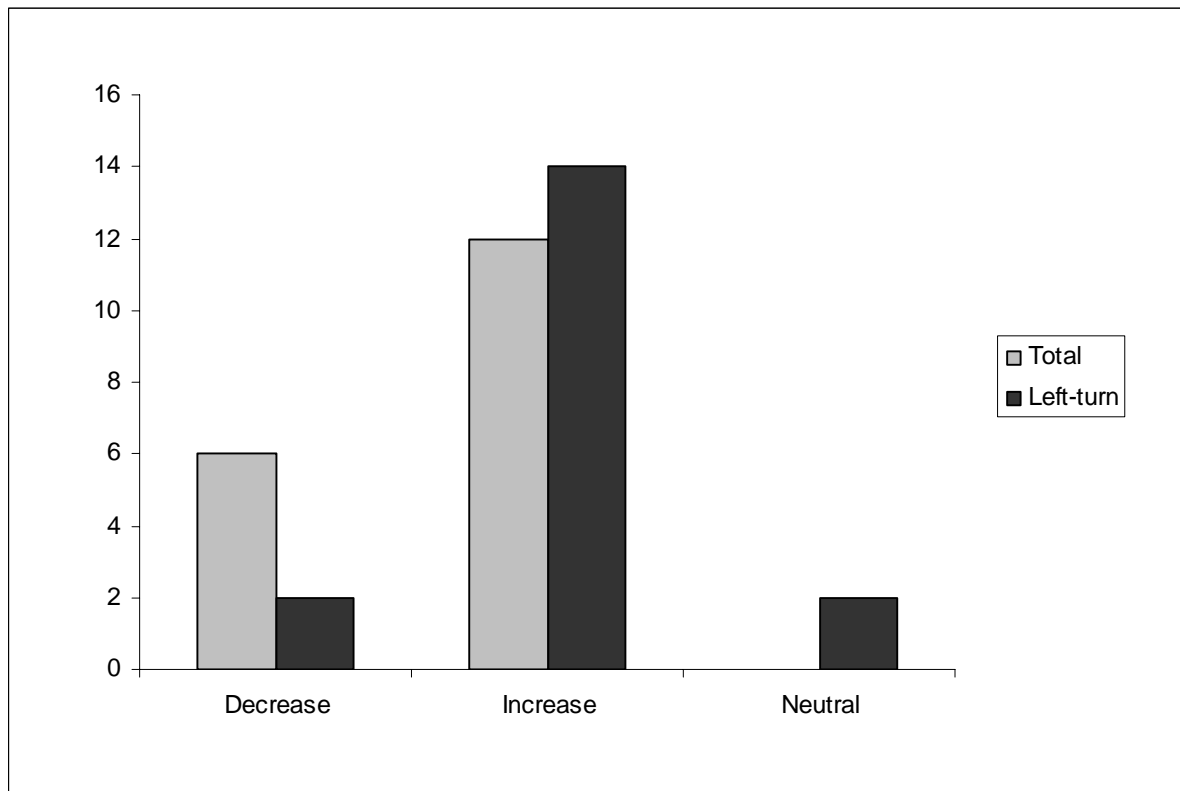

FIGURE 18 Group B Sign Test Results for Total Crashes and Left-turn Crashes

TABLE 10 Binomial Test Results for Group B

Crash Level	Variable			Binomial Test Results	
	X	N	P	B(x; n, p)	Two-tailed Test
Total	12	18	0.5	0.071	0.142
Left-turn	14	16	0.5	0.002	0.004
FYA Left-turn	13	14	0.5	0.001	0.002

As shown in Table 10, there is not sufficient evidence to conclude that total crashes at Group B sites changed after the implementation of PPLT signal phasing with the FYA indication ($\alpha = 0.05$). However, there is statistical evidence to suggest that left-turn crashes increased when signal phasing changed from protected only to PPLT with the FYA indication. This latter result is not surprising given the additional permissive left-turn phase.

Given the limited number of Group C sites, no formal analysis was completed.

Linear Trend Analysis

A Linear Trend Analysis was considered as a second means of looking at each study site before and after the implementation of the FYA indication. A linear relationship was fit to the annual crash frequency data collected prior to implementation of the FYA indication and/or display. The linear relationship was used as a simplified means to forecast the expected crashes after implementation should the FYA left-turn indication not have been implemented. A comparison was made between the forecasted linear estimation of annual crash frequency after implementation, with the observed annual crash frequency during the same period.

The number of sites evaluated varied for total, left-turn, and FYA left-turn crash analyses. This variation is a result of several sites where the linear trend line falls below zero, which is an unrealistic result. Where this occurred the site was not included in the linear trend analysis and a value of zero was recorded in the summary tables below.

Both total crashes and left-turn crash groups were analyzed. The plotted data for study groups A, B, and C is provided in Appendices H and I. When the observed crash frequency in the after period fluctuated above and below the linear expectation line, a neutral response was recorded. Tables 11 and 12 summarize the linear trend analysis results along side of the results of the sign test. Graphical summaries of the linear trend analysis results for Groups A and B are presented in Figure 19 and 20, respectively.

The linear trend analysis results provide a graphical result similar to the results of the sign test analysis. Specifically, sites changed from PPLT phasing to PPLT phasing with the FYA indication have shown a decrease in crash frequency. Similarly, Group B sites are consistent between the two testing methods. More sites increased in total and left-turn crash frequency when converted from protected only left-turn phasing to PPLT with the FYA indication.

TABLE 11 Total Crash Comparison Results, Including Linear Trend Analysis

ID	Intersection Name	Months of Crash Data (Before/ After)	Average Annual Frequency Comparison	Linear Trend Comparison
Group A: Protected/Permitted Left-turn Control				
43	US 117 (S. College Rd.)/Big K	60/12	-	+
45	125th Avenue/Longhorn Drive	36/55	-	0
49	Allen Boulevard/Menlo Drive	36/48	-	-
50	Allen Boulevard/Wilson Avenue	36/48	-	-
67	Pine(Biddle Road)/Hamrick	60/60	-	-
81	ORE 10/White Pine	48/18	-	-
85	ORE 99E/ Hardcastle Street	24/54	-	0
86	ORE 99E/ Lincoln Street	24/48	-	-
92	Duke Street/ 4600/ Fox Chase	36/24	-	-
93	Duke Street/ Jordan Street	36/24	-	-
98	Mullen Road/ Ruddell Road	36/24	-	-
100	128th St. SW/ 5th Place West	60/17	+	+/-
101	164th St SE/ 9th Ave/Main/Mill	22/21	-	N/A*
Group B: Converted from Protect Left-turn Control				
1	Magnolia Avenue/Park Avenue	36/12	+	N/A*
4	Orangethorpe Ave./Lemon Street	60/19	+	+
28	Brighton Rd./Brighton H.S. Entrance	60/24	-	-
29	Old US-23/Spencer Rd E	60/24	-	+
30	Old US-23/Spencer Rd W	60/24	-	-
58	Hall Boulevard/Nimbus Avenue	60/18	-	0
66	Main Street/Lozier Lane	60/48	+	+/-
69	Pine/NB I-5 Ramp	72/24	+	+
70	Pine/SB I-5 Ramp	72/24	+	+
72	Table Rock/Antelope	60/60	+	+
73	Table Rock/Biddle Road	60/48	+	0
75	ORE 10/107th	60/19	+	+
76	ORE 10/110th	60/20	+	0
78	ORE 10/91st	60/19	+	0
79	ORE 10/Laurelwood	60/19	-	-
80	ORE 10/Western	60/19	-	-
103	Airport Road/ Admiralty Way	60/12	+	-
104	Airport Road/ Gibson Road	60/12	+	+
Group C: Converted from Permitted Left-turn Control				
7	Table Mesa Drive/Tantra Drive	60/27	-	+
53	Beaverton-Hillsdale Highway/ Griffith Dr.	60/24	+	+/-
82	N. Hayden Island Drive/Center Street	60/17	-	0
87	US 26/ORE 211	60/16	+	-

*Unable to plot linear trend for the 164th Street SE/9th Avenue/Mill Creek Boulevard intersection in Mill Creek, Washington, and the Magnolia Avenue/Park Avenue intersection in El Cajon, California due to insufficient annual crash history.

TABLE 12 Left-Turn Crash Comparison Results Including Linear Trend Analysis

ID	Intersection Name	Months of Crash Data (Before/ After)	Average Annual Frequency Comparison	Linear Trend Comparison
Group A: Protected/Permitted Left-turn Control				
43	US 117 (S. College Rd.)/Big K	60/12	-	-
45	125 th Avenue/Longhorn Drive	36/55	-	0
49	Allen Boulevard/Menlo Drive	36/48	-	-
50	Allen Boulevard/Wilson Avenue	36/48	-	+/-
67	Pine(Biddle Road)/Hamrick	60/60	-	+/-
81	ORE 10/White Pine	48/18	-	-
85	ORE 99E/ Hardcastle Street	24/54	-	-
86	ORE 99E/ Lincoln Street	24/48	-	-
92	Duke Street/ 4600/ Fox Chase	36/24	-	+/-
93	Duke Street/ Jordan Street	36/24	-	0
98	Mullen Road/ Ruddell Road	36/24	-	+/-
100	128 th St. SW/ 5th Place West	60/17	-	-
101	164 th St SE/ 9th Ave/Main/Mill	22/21	-	N/A*
Group B: Converted from Protect Left-turn Control				
1	Magnolia Avenue/Park Avenue	36/12	+	N/A*
4	Orangethorpe Ave./Lemon Street	60/19	+	+
28	Brighton Rd./Brighton H.S. Entrance	60/24	+/-	0
29	Old US-23/Spencer Rd E	60/24	+/-	0
30	Old US-23/Spencer Rd W	60/24	-	-
58	Hall Boulevard/Nimbus Avenue	60/18	-	+/-
66	Main Street/Lozier Lane	60/48	+	+/-
69	Pine/NB I-5 Ramp	72/24	+	+
70	Pine/SB I-5 Ramp	72/24	+	+/-
72	Table Rock/Antelope	60/60	+	+
73	Table Rock/Biddle Road	60/48	+	+
75	ORE 10/107 th	60/19	+	+
76	ORE 10/110 th	60/20	+	+
78	ORE 10/91 st	60/19	+	+
79	ORE 10/Laurelwood	60/19	+	-
80	ORE 10/Western	60/19	+	-
103	Airport Road/ Admiralty Way	60/12	+	-
104	Airport Road/ Gibson Road	60/12	+	+
Group C: Converted from Permitted Left-turn Control				
7	Table Mesa Drive/Tantra Drive	60/27	-	-
53	Beaverton-Hillsdale Highway/ Griffith Dr.	60/24	-	+/-
82	N. Hayden Island Drive/Center Street	60/17	+	0
87	US 26/ORE 211	60/16	-	0

*Unable to plot linear trend for the 164th Street SE/9th Avenue/Mill Creek Boulevard intersection in Mill Creek, Washington, and the Magnolia Avenue/Park Avenue intersection in El Cajon, California due to insufficient annual crash history.

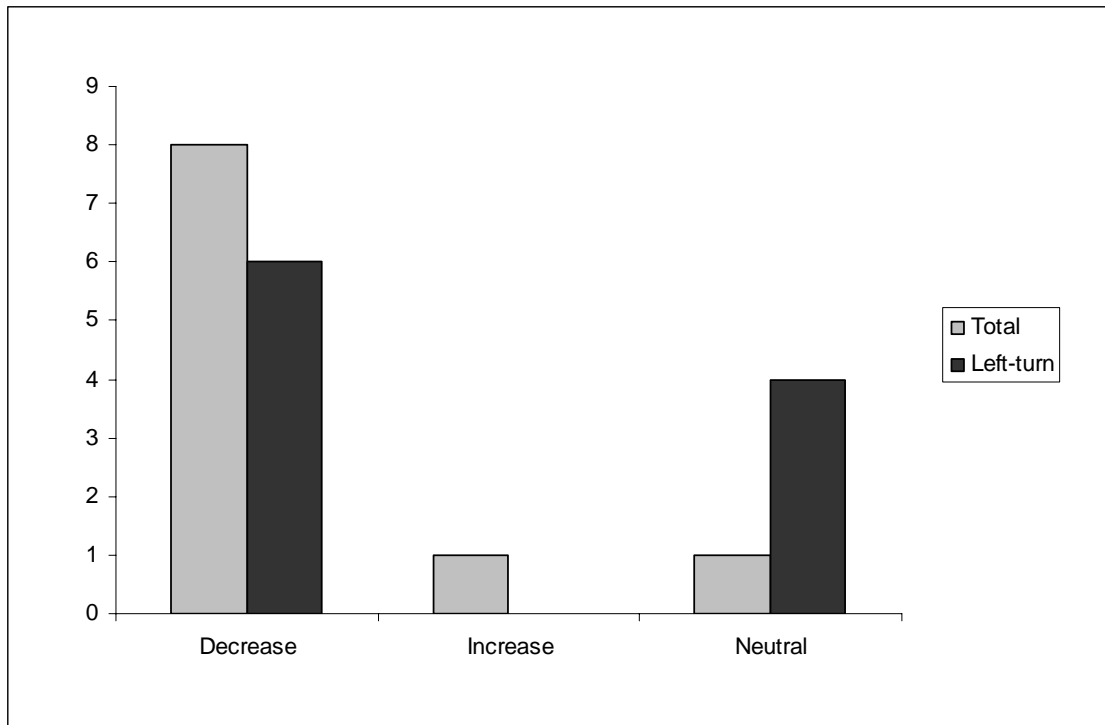

FIGURE 19 Group A Linear Trend Analysis Results for Total Crashes and Left-Turn Crashes

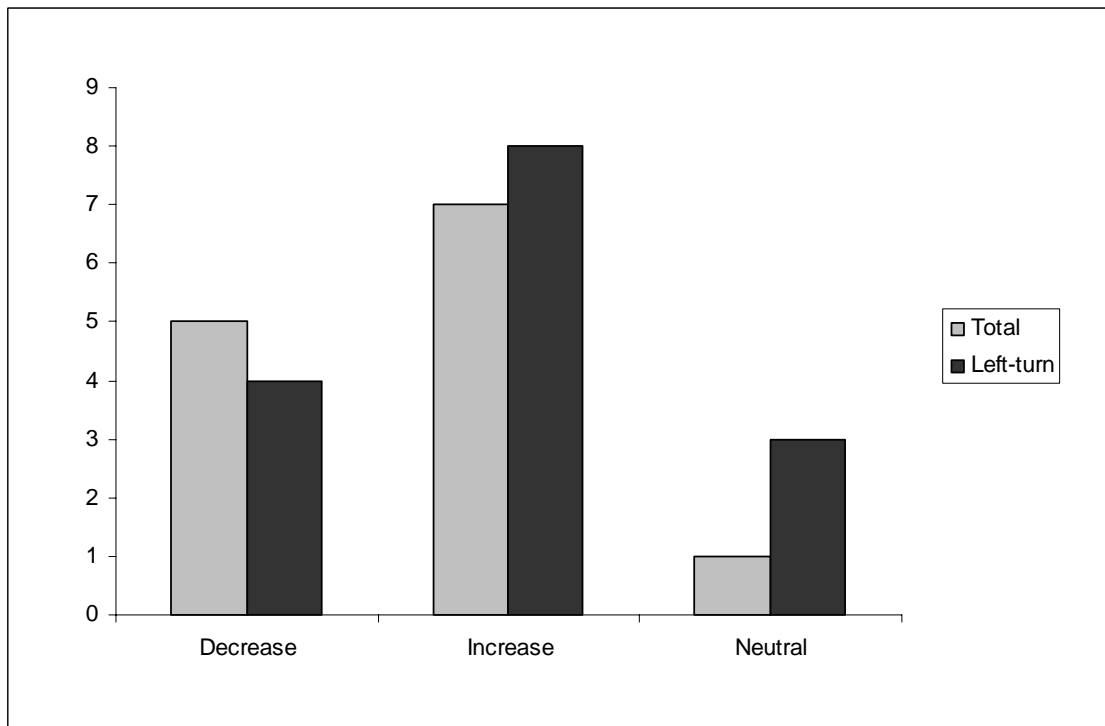

FIGURE 20 Group B Linear Trend Analysis Results for Total Crashes and Left-Turn Crashes

Empirical Bayes Method Statistical Analysis Results

Nineteen intersections with left-turn crashes ‘before’ and ‘after’ the implementation of the FYA with sufficient supporting data were available for the EB analysis. The population crash mean was found to be 2.34 with an estimated variance of 6.30. The weighting factor was computed to be 0.2709 for the selected intersections. Results of the analysis are presented in Table 13.

Fifteen of the 19 intersections with the FYA implementation with PPLT signal phasing showed a significant reduction in crashes. Only two intersections showed an increase in crashes after the FYA was implemented. Results were consistent with previous analysis methods.

TABLE 13 Left-Turn Crash Results Using the EB Methodology

ID	Location/Jurisdiction	Average Left Turn Crashes Before FYA	Average Left Turn Crashes After FYA	Expected Mean	t value	Significant Crash Reduction (Y/N) at $\alpha=.20$
6	Boulder, CO	8.33	10.08	6.7101	2.4992	N
8	Broward Co., FL	3.00	0.66	2.8217	2.4648	Y
11	ITD_Nampa, ID	0.50	0.50	0.9990	0.9592	N
42	NCDOT_Wake Co., NC	3.20	0.00	2.9675	3.3096	Y
43	NCDOT_New Hanover Co., NC	9.20	0.00	7.3420	5.2058	Y
45	Beaverton, OR	1.00	0.00	1.3636	2.2434	Y
49	Beaverton, OR	2.00	1.00	2.0926	1.4511	Y
50	Beaverton, OR	0.33	0.00	0.8775	1.7997	Y
67	Jackson Co., OR	0.80	0.00	1.2177	2.1201	Y
68	Jackson Co., OR	0.60	0.00	1.0719	1.9891	Y
81	ODOT_Beaverton, OR	0.75	0.00	1.1813	2.0881	Y
85	ODOT_Woodburn, OR	0.50	0.22	0.9990	1.4931	Y
86	ODOT_Woodburn, OR	1.00	0.25	1.3636	1.8329	Y
92	Alexandria, VA	1.33	1.00	1.6066	0.9194	N
93	Alexandria, VA	0.00	0.00	0.6345	1.5303	Y
96	Kennewick, WA	1.75	6.94	1.9104	7.0012	N
97	Kennewick, WA	2.00	0.66	2.0926	1.8938	Y
98	Lacey, WA	4.00	1.66	3.5508	1.9210	Y
100	Snohomish Co., WA	4.20	2.10	3.6966	1.5954	Y

Regression Results

Average annual crash frequency was analyzed using linear regression to investigate the effect of several potential independent variables on the crash frequencies observed. The independent variables included both covariates (i.e., continuous factors) and discrete factors. The covariates included:

- ADT before;
- ADT after;
- Volume ratio (after/before);
- Total crashes before;
- Left-turn crashes before; and
- Target crashes before.

The discrete factors included (levels in parenthesis):

- Approaches implemented with the FYA indication (1, 2, 4);
- Average through traffic lanes opposing FYA left-turn lane (1, 1.5, 2, 2.5, 3);
- Posted speed limit on FYA approach (25, 30, 35, 40, 45 mph); and
- Months of crash data after implementation.

The linear regression analysis of Group A and Group B was performed in statistical software (15). Analysis of Group C was not feasible due to the limited number of data points. Tables 13 and 14 summarize the independent variables found to significantly affect crash frequency after implementation of the FYA indication. Statistical output is provided as Appendix J.

TABLE 14 Group A Regression Analysis Results

Evaluation Scenario	Variable	Coefficient	P-value	R ²	R ² (adjusted)
Total Crashes (13 sites)	Constant	0.91	0.092	92.9	90.5
	Opposing TH Lanes	0.36	0.065		
	Approach Speed	-0.03	0.094		
	Crashes (Before)	0.19	0.000		
Total Crashes (11 Sites)	Constant	0.66	0.000	96.5	96.1
	Crashes (Before)	0.18	0.000		
Left-turn Crashes	Constant	-0.19	0.326	84.2	82.8
	Crashes (Before)	0.18	0.000		
FYA Left-turn Crashes	Constant	1.99	0.093	29.4	13.8
	Approach Speed	0.07	0.116		
	Crashes (Before)	0.16	0.091		

TABLE 15 Group B Regression Analysis Results

Evaluation Scenario	Variable	Coefficient	P-value	R ²	Adj. R ²
Total Crashes (After)	Constant	-3.54	0.024	73.7	70.2
	Volume Ratio	6.39	0.000		
	Months (After)	-0.03	0.000		
Left-turn Crashes (After)	Constant	1.60	0.001	56.1	46.7
	FYA Approaches	0.62	0.003		
	Months (After)	-0.05	0.012		
	Crashes (Before)	-0.07	0.073		

The least-squares linear regression equation resulting from the analysis of total crashes observed at 13 study sites is:

$$\text{sqrt}(A_TCrash) = 0.911 + 0.357 * \text{OppThLanes} - 0.0315 * \text{AppSpeed} + 0.194 * B_TCrash \quad (3)$$

Where,

A_TCrash = total crash frequency in the after period.

OppThLanes = number of through lanes opposing the FYA left-turn approach.

AppSpeed = posted speed limit on intersection approaches.

B_TCrash = total crash frequency in the before period.

The directions of the parameter estimates in Equation 3 indicate that average crash frequency increased as the number of through lanes opposing the FYA left-turn increased, decreased as posted speed limits increased, and increased as the frequency of crashes in the before period increased. With the exception of the approach speed, the parameter estimates match expectations. The approach speed parameter indicates that the crash frequency after implementation of the FYA will decrease as the posted speed on the intersection approach increases, which is counterintuitive. This parameter estimate may be a reflection of the limited number of observations, which result in large variation of crash frequency with respect to speed. To show this, Figure 21 provides a plot of approach speed and crash frequency. Figure 21 shows one data point that has much greater crash frequency at a speed of 35 miles per hour. This is not believed to be an outlier of significance, but is a reflection of the crash variation within a given posted speed range. This data point consistently follows data trends shown in plots of other study variables against the crash frequency.

In order to further investigate the effect of approach speed on crash frequency, a regression analysis was conducted for before crash frequency on the response of after crash frequency.

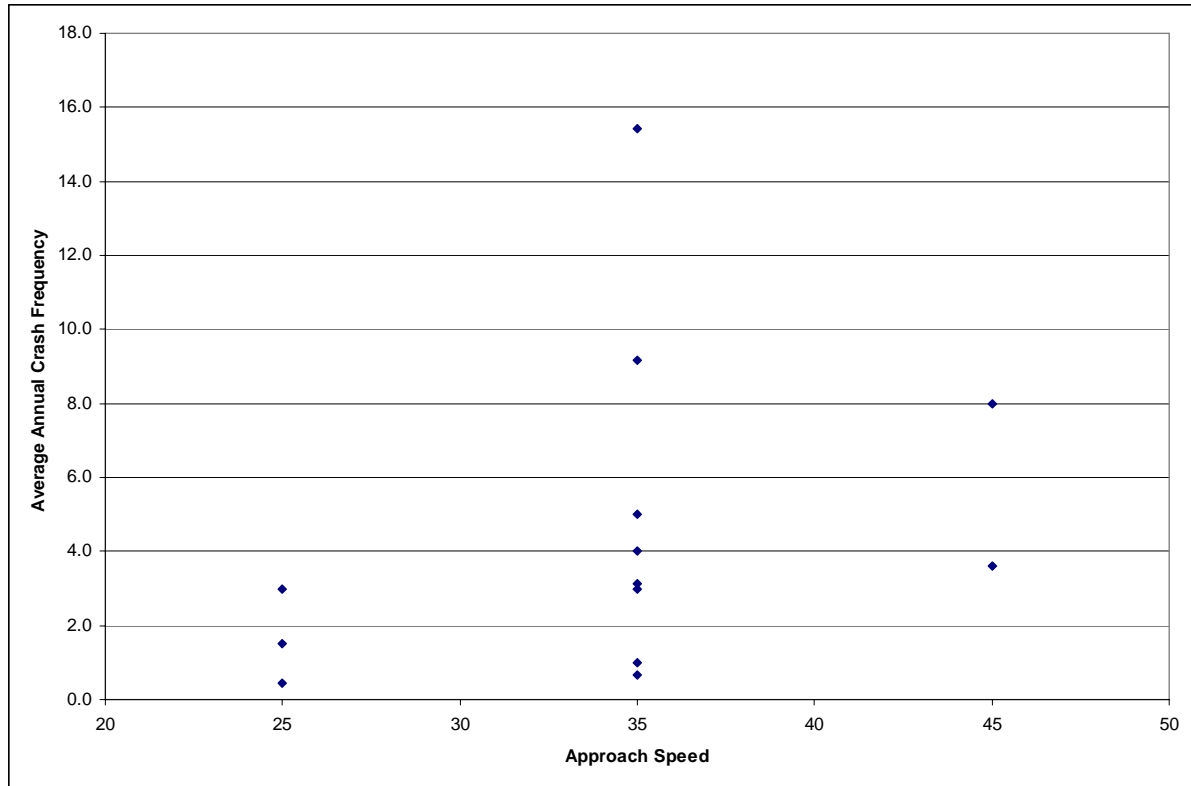

FIGURE 21 Total Crash Frequency as a Function of Approach Speed

The resulting model is:

$$(A_TCrash) = -1.14 + 0.846 * B_TCrash \tag{4}$$

Where,

A_TCrash = total crash frequency in the after period.

B_TCrash = total crash frequency in the before period.

The residuals for each observation were then plotted versus the approach speed, as shown in Figure 22. The directions of the parameter estimates in Equation 4 indicate that average crash frequency increased as the frequency of crashes in the before period increased. The negative constant shows that a reduction in crashes between the before and after period occurred apart from the impact of the number of crashes in the before period. This is a reflection of other variables that are not explicitly included the model.

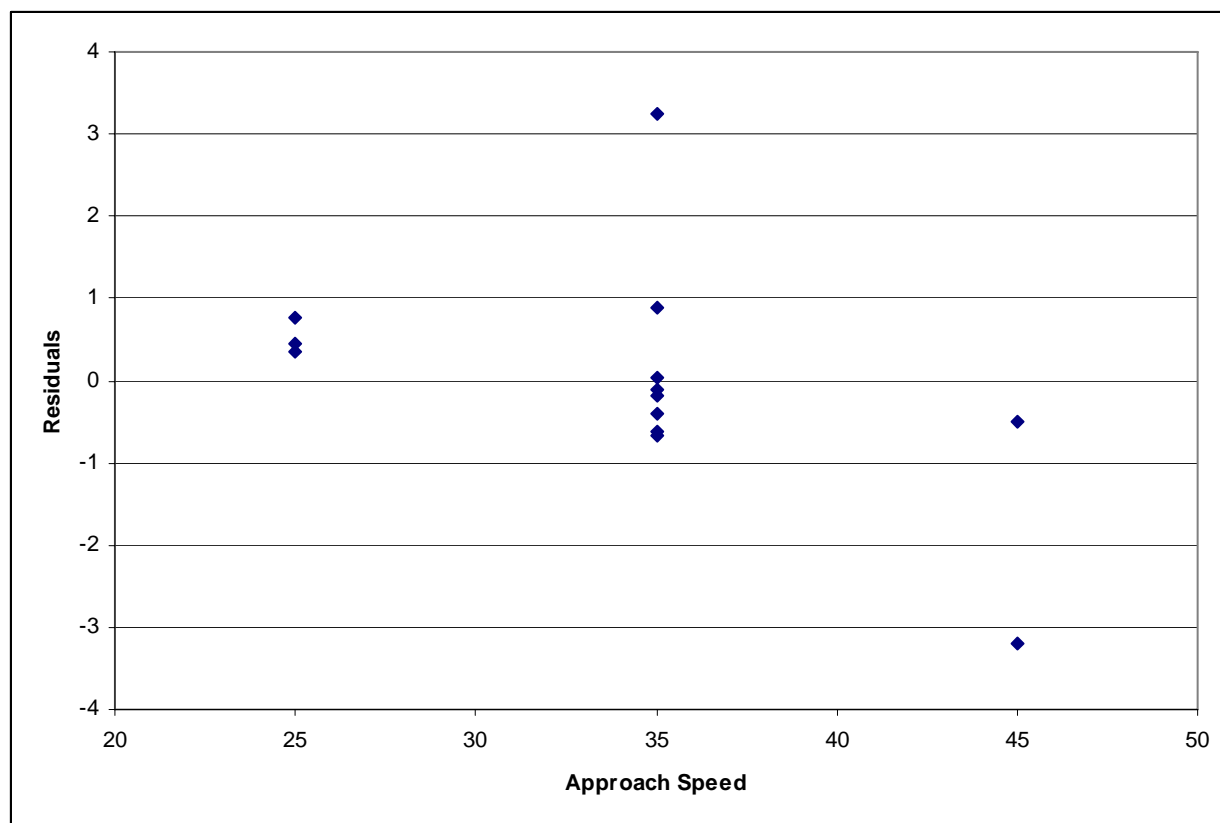

FIGURE 22 Analysis of Residuals vs. Approach Speed

The two largest residuals shown in Figure 22 (observations 5 and 12) are expected to be the primary points that led to a negative coefficient for approach speed in Equation 4. The reduced model of total crashes that results from removing the two largest residuals is:

$$\text{sqrt}(A_TCrash) = 0.66 + 0.184 * B_TCrash \quad (5)$$

Where,

A_TCrash = total crash frequency in the after period.

B_TCrash = total crash frequency in the before period.

The reduced model includes only one significant variable, the total crash frequency in the before period. Models developed for left-turn crash frequency also include the total crash frequency in the before period as a significant variable. This finding suggests that crash frequency in the before period is a significant variables in predicting the number of crashes in the after period. In other words, a change in left-turn phasing is not a major contributor to changes in total crashes.

Group B regression analysis results are summarized in Table 14. Analysis was performed for three response variables: total crashes, left-turn crashes, and FYA approach left-turn crashes. There were not enough crashes included in the FYA left-turn category to develop an accurate regression model for that response variable.

The least-squares linear regression equation resulting from the analysis of total crashes observed at 18 study sites is:

$$\text{sqrt}(A_T\text{Crash}) = -3.54 + 6.39 * \text{VolumeRatio} - 0.03 * A_Months \quad (6)$$

Where,

A_TCrash = total crash frequency in the after period.

VolumeRatio = the ratio (After/Before) of ADT volumes.

A_Months = number of months in the after period.

The directions of the parameter estimates in Equation 6 indicate that average crash frequency is expected to increase as the ratio of traffic volumes from the before and after periods increase, and decrease as the number of months in the after period increase. These trends are in accordance with general expectations and reports for the traffic engineers who have installed the FYA indications. Crashes have been found to decrease with time.

The second linear regression equation developed for Group B data estimated the left-turn crash frequency with the following equation:

$$\text{sqrt}(A_L\text{TCrash}) = 1.60 + 0.62 * \text{NumFYAApproaches} - 0.05 * A_Months - 0.07 * B_Crash \quad (7)$$

Where,

A_TCrash = total crash frequency in the after period.

NumFYAApproaches = the number of intersection approaches implemented with the FYA indication

A_Months = number of months in the after period.

B_Crash = average annual crash frequency before implementation of the FYA indication.

The directions of the parameter estimates in Equation 7 indicate that average left-turn crash frequency is expected to increase as the number of approaches implemented with the FYA indication increase, and decrease with the number of months in the after period. This result is further presented in Figures 23 and 24 which show how crash rates decrease with time.

The number of crashes is not expected to directly relate to the number of approaches that are implemented with the FYA display, but indirectly it is believed that the number of approaches may reflect the traffic demand. It is generally observed from the complete inventory of implementation sites that the FYA display and PPLT phasing is most often applied to the major street of a four-way signalized intersection, and on all four approaches where the crossing volumes are even.

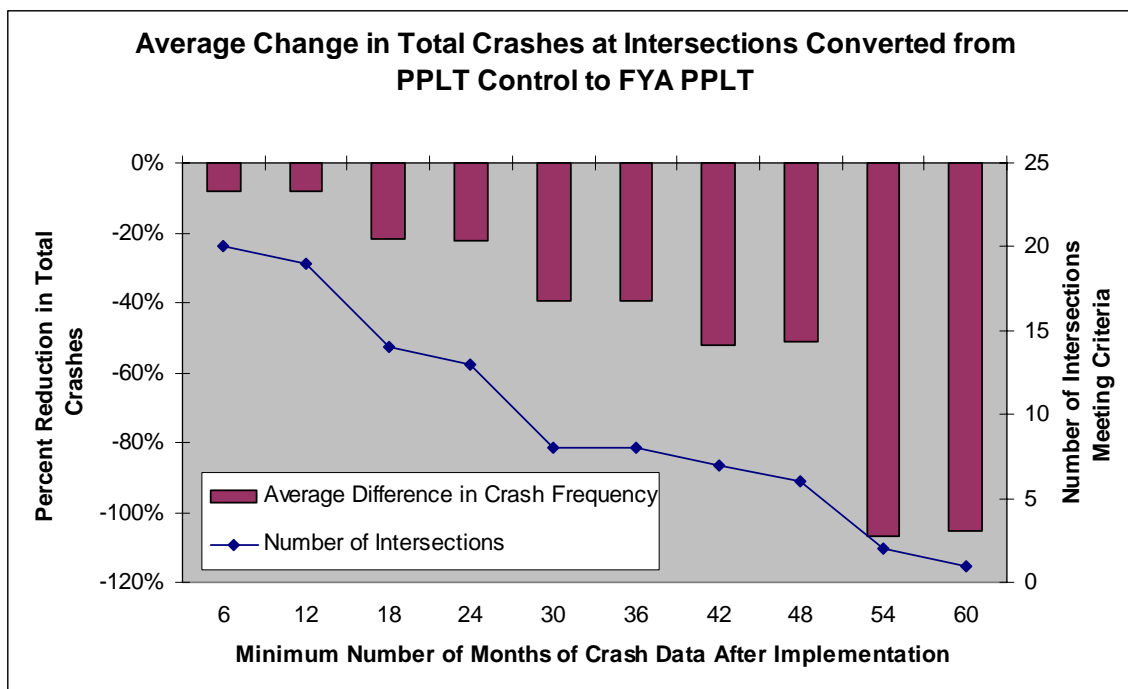

FIGURE 23 Changes in total Crashes in PPLT to FYA PPLT Conversions

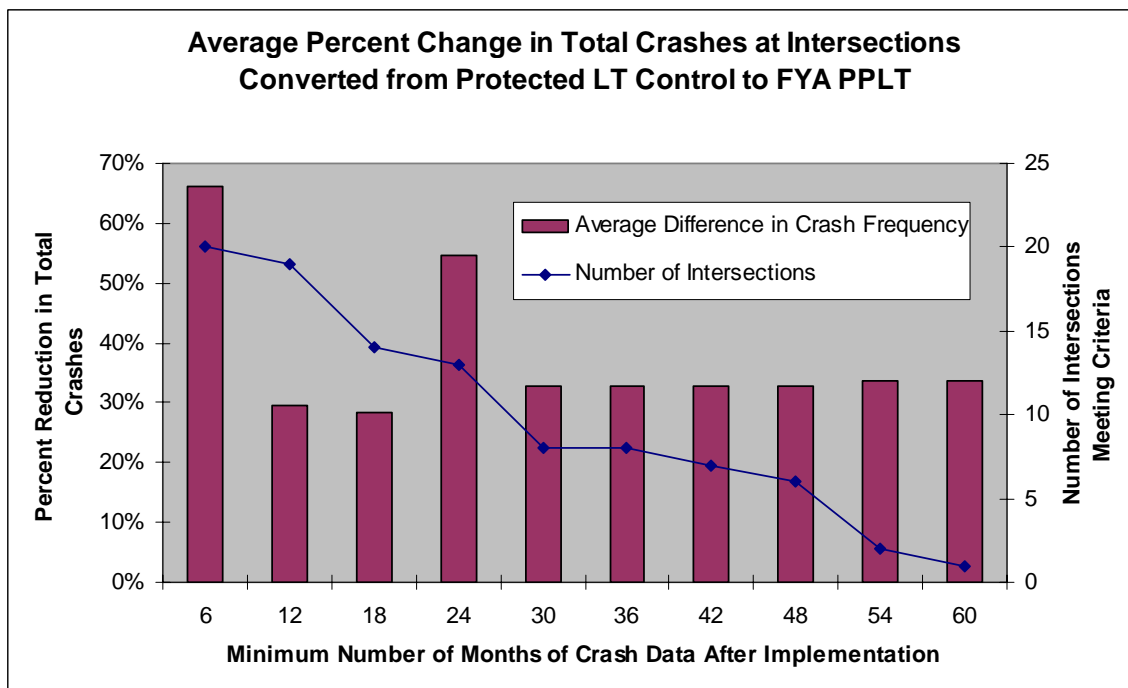

FIGURE 24 Changes in total Crashes in Protect LT to FYA PPLT Conversions

CHAPTER 5 – INSTALLATION METHODS FOR FYA SIGNALS

FYA Indication Installation

The installation of the flashing yellow arrow indications has not been without challenges to those jurisdictions that have attempted it. Successful operations have, in some instances, required the writing of new command code, installation of additional logic boards, and the configuration of numerous jumpers within the controller cabinet. The difficulties primarily arise when dealing with older controller equipment/firmware or software. Certain newer controller types/firmware are either already programmed for an FYA interval or should be in the near future. The difficulty, therefore, arises when older controllers are used in an intersection retrofitting to an FYA. Information provided by several responding jurisdictions have allowed the inclusion of a list of controller types/firmware in which installations have been successful, and some of the methods needed to accomplish this task.

Table 15 lists the controller types and corresponding manufacturer, model, and firmware for which FYA installations have been successful. Also included is whether or not any external logic was necessary, and what, if any, conflict monitors are being used. As may be noted, FYA installations are possible with a wide range of controller types, and indications from jurisdictions with successful installations are that controller equipment manufacturers &/or suppliers have been very helpful in making these installations successful. Learning from the experiences of those who have implemented the FYA is encouraged by contacting one or more of the agencies listed.

Successful installation methods for a 170E controller running BITrans 233, and for a NEMA TS-2, Type 2 Eagle M50 series controller running Econolite Oasis are presented.

170E Controller Setup

A 170E controller (McCain Traffic) running BITrans 233 software required the addition of an EDI model 210ECL conflict monitor, programmed in a specific manner. Even the most basic configurations are rather technical, so, thanks to the generosity of the implementing jurisdiction, two electrical detail sheets are reproduced as Figures 25 and 26.

NEMA TS-2, Type 2 Controller Setup

The second installation methodology to be reported on is for a NEMA TS-2, Type 2 Eagle M50 series controller running Econolite Oasis. This installation required the addition of a NEMA TS-1 conflict monitor due to the jurisdiction's current wiring scheme. No wiring diagrams were available for this installation; however a detailed explanation was provided.

The intersection is running an Eagle M50 controller running the Econolite *Oasis* firmware package. Despite being designed for a 2070, *Oasis* will also run on an Eagle controller. The *Oasis* firmware allows for the creation of flashing outputs directly in the controller which eliminates the need for any external flasher circuits. *Oasis* also allows these outputs to be assigned in the controller to the appropriate pins on the MS-A, B, and C. The flashing yellow arrows were driven off the unused load switch positions on the pedestrian load switches, which required the installation of several sets of jumpers in the cabinet. A NEMA TS-1 conflict monitor was used in the intersection (due to slightly different wiring,

the EDI SSMLE-FYA conflict monitor was not a viable option). To allow the intersection to run properly, the yellow monitoring on the conflict monitor had to be disabled.

TABLE 16 Summary of Successful FYA Installations by Controller Type

Controller Type	Controller Manufacturer/ Model/Firmware	External Logic Used (Y/N)	Conflict Monitor
170	BITrans 233	N	EDI 210E
170	BITrans 233	N (5 outputs to 3 section head)	EDI 210ECL
170	Wapiti	Y (flasher in head)	
170E	McCain - BITrans 233NC2	N	EDI 210ECL (remove jumpers and switches as shown)
170E	Wapiti	Y (flasher in head)	EDI 210 + modified diode card
170E	Wapiti	N	EDI 210 (via unused overlap channels)
2070L	AECOM - Econolite Oasis	N	EDI 2010
2070L	Eagle - Econolite Oasis	N	EDI 2010ECL (remove jumpers and switches as shown)
NEMA	Eagle EPAC 300	N	EDI MMU16-LE
NEMA	Peek 3000	N	Peek LMD
NEMA TS-1	Eagle EPIC	N	EDI custom 6 & 12 channel
NEMA TS-1	ECPI - KMC 8000	Y	
NEMA TS-1	LMD 8000	N	Peek LNM 12E
NEMA TS-1	Traconex TMP-390	N	NEMA TS-1 (install jumpers as shown)
NEMA TS-2	Eagle EPAC M52	N	EDI
NEMA TS-2, Type 1	Eagle Econolite ASC/3	N	EDI MMU16-LE
NEMA TS-2, Type 1	Eagle Econolite 2070 - Northwest Signal Supply IDTS2	N	EDI 16E
NEMA TS-2, Type 2	Eagle EPAC M50	N	
NEMA TS-2, Type 2	Eagle EPAC M50 - Econolite Oasis	N	NEMA TS-1
NEMA TS-2, Type 2	Eagle EPAC M52 - EPAC v3.33b+	N	EDI SSMLE-FYA (12 channel)
NEMA TS-2, Type 2	Eagle EPAC M52 - SCATS v. s15	N	EDI SSMLE-FYA (12 channel)

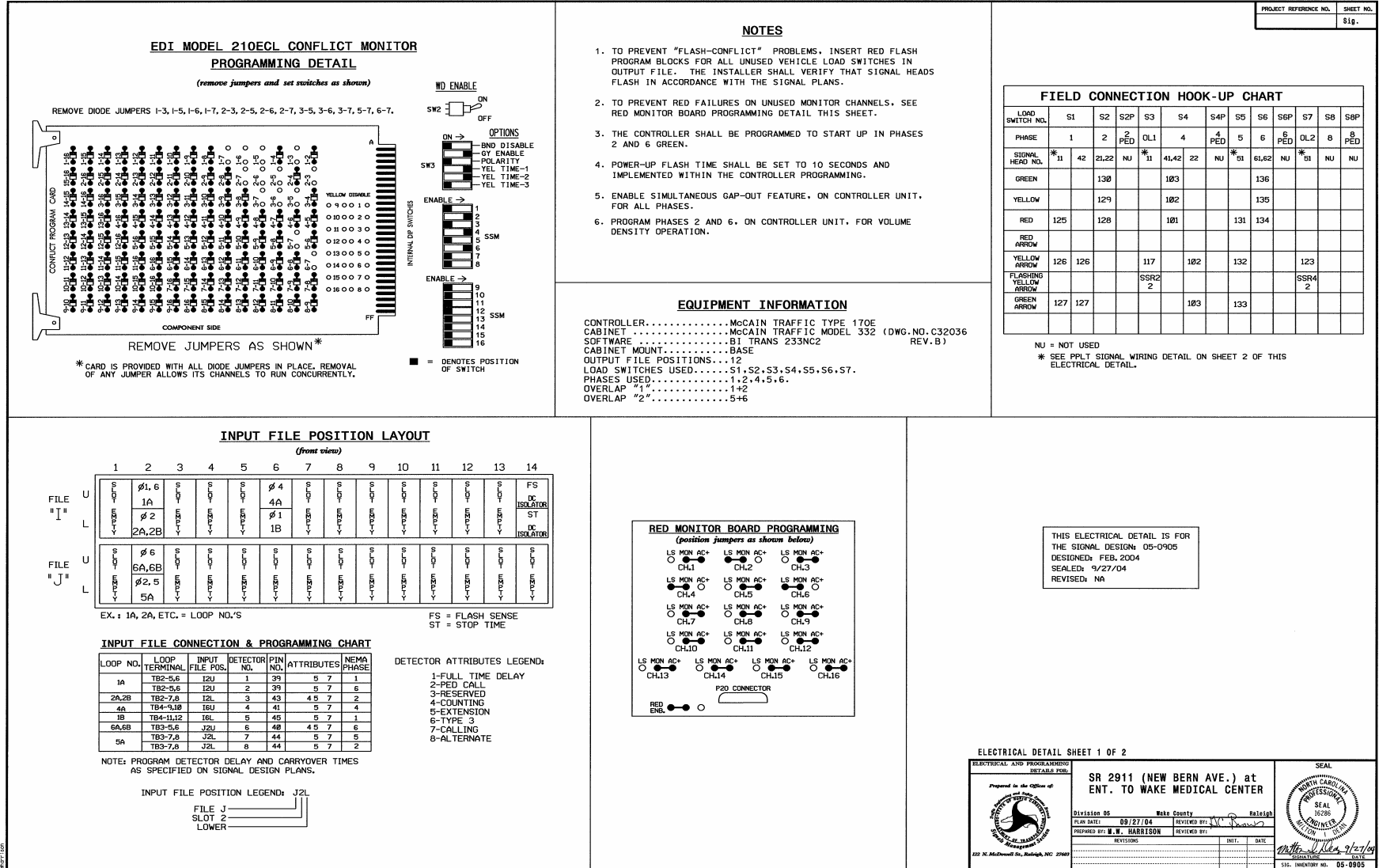

FIGURE 25 NCDOT Electrical Detail Sheet 1 of 2

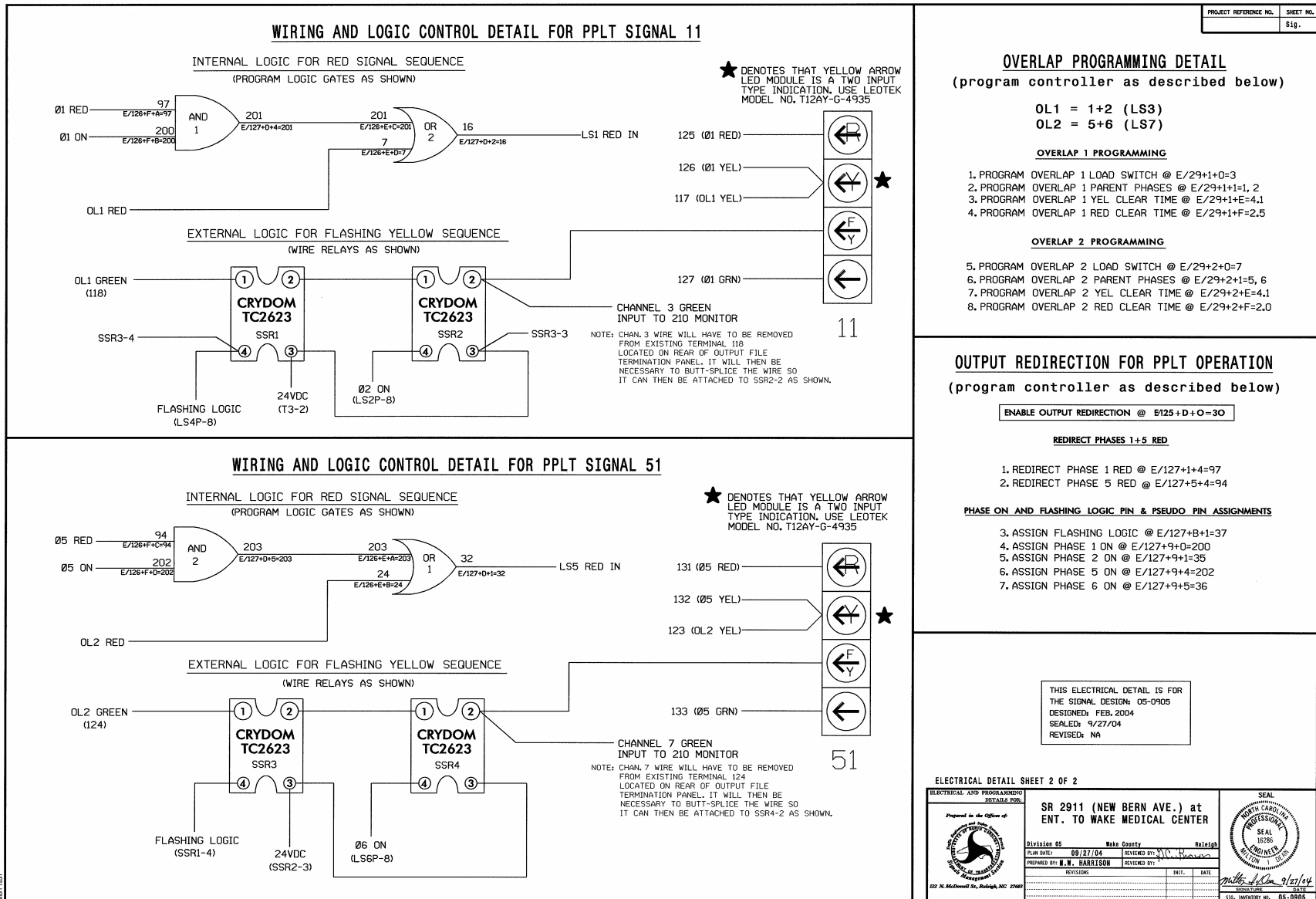

FIGURE 26 NCDOT Electrical Detail Sheet 2 of 2

CHAPTER 6 – CONCLUSIONS & DISCUSSION

Discussion

The FYA indication has been implemented at over 120 known locations throughout the U.S. These sites represent a widely varied cross-section of intersection types and sizes. None of the intersections in which the FYA indication was implemented was without some selection bias or without some change in operating conditions before and after the installation. Furthermore, none of the sites in which traffic engineers provided data were complete or comprehensive in terms of all desirable data desired for analysis. Nevertheless, the effects of a change in left-turn phasing and/or the implementation of the FYA indication were analyzed. Conclusions are presented below.

Conclusions are drawn from the data collection and analysis at over 50 intersections, where no significant changes are known apart from the implementation of the FYA indication. This evaluation resulted in three general conclusions:

- Safety was improved at intersections that operated with protected/permissive left-turn phasing prior to and after the field implementation of the FYA permissive indication.
- Safety was not improved at intersections that operated with protected only left-turn phasing prior to field implementation of the FYA indication with PPLT phasing.
- No conclusions can be made at intersections that operated with permissive only left-turn phasing prior to implementation of the FYA indication, due to a minimal number of implementation sites and data.

The following text provides details that support these conclusions.

Group A: Protected/Permissive Left-Turn Control

The following observations were made at Group A sites:

- The average annual frequency of total crashes was reduced at 12 of 13 sites after implementation of the FYA indication.
- The average annual frequency of left-turn crashes was reduced at all 13 sites after implementation of the FYA indication.
- The average annual crash frequency of left-turn crashes that occurred on an approach implemented with the FYA indication was reduced at all sites where detailed data was available.
- The EB analysis found significant reductions at 15 of the 19 intersections available for analysis.
- Statistical tests showed that sites changed from PPLT to PPLT with a FYA indication had significant decreases in crashes and a positive impact on safety.

Reduction of average annual crash frequency was observed at most study sites where few known changes have occurred, except for the change in left-turn indication from PPLT to

PPLT with the FYA indication. This finding is in accordance with expectations that safety of intersections would improve with use of the FYA indication. These expectations have been developed from several in-depth studies, including NCHRP Report 493, which concluded that the FYA indication provides the highest level of safety of any permissive left-turn indication (1).

Group B: Converted from Protected Left-Turn Control

The following general observations were made at Group B sites:

- Average annual frequency of total crashes was increased at 12 of 18 sites after implementation of the FYA indication.
- Average annual frequency of left-turn crashes was increased at 14 of 18 sites after implementation of the FYA indication.
- Average annual frequency of left-turn crashes that occurred on an approach implemented with the FYA indication was increased at 13 of 18 sites after implementation of the FYA indication.
- An average increase in crash frequency of between 0.7 to 1.3 crashes per year for total, left-turn, and FYA left-turn crashes was observed within an average period of 24 months after implementation.
- The least-squares linear regression equations resulting from the analysis of total crashes and left-turn crashes observed at 18 study sites showed that the number of months in the after period is a significant variable. As the number of months in the after period increase, the crash frequency decreases.

The observed changes in crash frequency at sites converted from protected only control to PPLT with the FYA indication show trends that are contrary to those observed for Group A sites. The crash frequency of a majority of intersections within this group increased after implementation of the FYA indication. This finding is in accordance with previous knowledge that adding a permissive phase to a protected left-turn phase to create PPLT signal phasing will increase crash frequency. Nevertheless, with time, crash rates did go down.

The primary finding of this research was that the installation of the FYA indication at sites which currently operate PPLT signal phasing showed improvements in safety. In other words, the use of the FYA for the permissive left-turn indication led to a reduction in intersection crashes. In other locations, it was found that the change in left-turn signal phasing (protected only to PPLT) had a more significant impact on safety than the change in left-turn indication, although the addition of the FYA was associated with safety improvements with time.

Future Evaluations

It is inevitable that several independent variables, in addition to those included in the regression analysis, factor into the change in crash frequency between the before and after periods. An example is median width at an intersection. As discussed in Chapter 2, the wide median case is expected to influence the safety of left-turn movements and should be considered as a special case if implemented with the FYA indication at a future date. No wide median installations were found with a FYA. Additionally, change in protected left-

turn phasing from lead-lead to lead-lag or vice-versa has potential to impact crash frequency and should be evaluated. This study did not look at either variable due to lack of available data.

Additional types of data are expected to be relevant to this study, but due to their unavailability at the present time, they were not considered. Such data includes:

- Left-turn crash reporting of the signal phase/interval that was present at the time of the crash.
- A measure (level of service, volume-to-capacity ratio, average delay, etc.) of the operational conditions before and after implementation.
- In-vehicle, real-time driver behavior (e.g., recording of eye-movement, driver attentiveness to driving task, and perceived stress level).

It has also been noted that a disaggregated analysis of individual components that effect safety of signalized intersections would prove valuable and may be necessary to confidently make conclusions regarding the expected crash frequency.

Further evaluations can improve the strength of the statistical results by including a larger number of 'after' years in the data set and improving the completeness of the data available for analysis. Most traffic engineers do not keep a comprehensive set of traffic and operational data on each of their signalized intersections. Evaluation of individual sites, where known changes occurred apart from the implementation of the FYA indication, was not included in this report. Many unique situations have been identified at these sites and it is expected that evaluation of each may provide valuable insight into the factors that impact the safety of permissive left-turns. Individual intersection data were included in the appendices.

REFERENCES

1. Brehmer, C. L., Kacir, K. C., Noyce, D. A., and M. P. Manser. Evaluation of Traffic Signal Displays for Protected/Permissive Left Turn Control. *NCHRP Report 493*, TRB, National Research Council, Washington D.C., 2003.
2. Interim Approval for Optional Use of Flashing Yellow Arrow for Permissive Left Turns (IA-10). FHWA Policy Memorandums. FHWA, Washington, D.C.
http://mutcd.fhwa.dot.gov/resources/interim_approval/ia_10_flashyellarrow.htm. Accessed 08/20/2007.
3. National Committee on Uniform Traffic Control Devices – Signals Technical Committee. Texas A&M University, College Station, TX. <http://tcd.tamu.edu/documents/stc/stc.htm>. Accessed 08/20/07.
4. Knodler, M. A., Jr. and D. A. Noyce. Tracking Driver Eye Movements at Permissive Left-Turns. Presented at the 3rd International Driving Symposium on Human Factors in Driver Assessment, Training, and Vehicle Design. Rockport, Maine, 2005.
5. Manual on Uniform Traffic Control Devices, 2003 Edition, Revision 1. Federal Highway Administration, U.S. Department of Transportation, Washington, DC, 2004.
6. Knodler, M. A., Jr., Noyce, D. A., Kacir, K. C., and C. L. Brehmer. Evaluation of Flashing Yellow Arrow in Traffic Signal Displays with Simultaneous Permissive Indications. In *Transportation Research Record: Journal of the Transportation Research Board*, No. 1918, TRB, National Research Council, Washington, D.C., 2005, p. 46-55.
7. Knodler, M. A., Jr., D. A. Noyce, and D. L. Fisher. Evaluating the Impact of Two Allowable Permissive Left-turn Indications. Prepared for the 86th Annual Meeting of the Transportation Research Board, Washington, D.C., January, 2007.
8. Knodler, M. A., Jr., D. A. Noyce, Kacir, K. C., and C. L. Brehmer. An Evaluation of Driver Comprehension for Solid Yellow Indications Resulting from Implementation of the Flashing Yellow Arrow. Prepared for the 86th Annual Meeting of the Transportation Research Board, Washington, D.C., January, 2007.
9. Knodler, M. A., Jr., D. A. Noyce, Kacir, K. C., and C. L. Brehmer. Potential Application of the Flashing Yellow Arrow Permissive Indication in Separated Left-turn Lanes. In *TRB 85th Annual Meeting Compendium of Papers*. CD-ROM. Transportation Research Board of the National Academies, Washington, D.C., 2006.
10. Knodler, M. A., Jr., D. A. Noyce, Kacir, K. C., and C. L. Brehmer. An Analysis of Driver and Pedestrian Comprehension of Requirements for Permissive Left-turn Applications. In *TRB 85th Annual Meeting Compendium of Papers*. CD-ROM. Transportation Research Board of the National Academies, Washington, D.C., 2006.
11. Lord, D. Procedure to Estimate Missing Year-to-Year Traffic Counts at Intersections. 3rd Transportation Specialty conference of the Canadian Society of Civil Engineering, London, Ontario, June 2000.
12. Niemeyer, Eric. Flashing Yellow Arrow for Protected/Permissive Left Turns at Signalized Intersections. Presented at ITE 2005 Annual Meeting, Melbourne, Australia, 2005.
13. Blincoe, L., et al. *The Economic Impact of Motor Vehicle Crashes, 2000*. National Highway Traffic Safety Administration. Washington, D.C., 2002.

14. Washington, S. P., M. G. Karlaftis, and F.L. Mannering. *Statistical and Econometric Methods for Transportation Data Analysis*. Chapman & Hall/CRC, Boca Raton, FL, 2003.
15. Neter, J., W. Wasserman, M. Kutner. *Applied Linear Statistical Models, 3rd edition*. Irwin. Homewood, IL. 1990.
16. Minitab Version 15.1.1.0. Minitab Inc. 2007.
17. Hauer, Ezra. *Observational Before-After Studies in Road Safety*. Pergamon Press, Elsevier Science Ltd., 1997.

APPENDIX A – FHWA INTERIM APPROVAL MEMORANDUM

Memorandum from:
Jeffrey Paniati
Associate Administrator for Operations
Federal Highway Administration (FHWA)

Interim Approval for Optional Use of Flashing Yellow Arrow for Permissive Left Turns



Memorandum

via Electronic Mail

Subject: **INFORMATION:** MUTCD – Interim Approval for
Optional Use of Flashing Yellow Arrow for
Permissive Left Turns (IA-10)

Date: March 20, 2006

From: Jeffrey P. Paniati
Associate Administrator for Operations

Reply to
Attn. of: HOTO-1

To: Division Administrators
Resource Center Director and Operations Managers
Federal Lands Highway Division Engineers

Purpose: The purpose of this memorandum is to issue an Interim Approval for the optional use of a flashing yellow arrow (FYA) signal indication as the signal display for left-turn movements during permissive turn intervals at signalized locations. Interim Approval allows interim use, pending official rulemaking, of a new traffic control device, a revision to the application or manner of use of an existing traffic control device, or a provision not specifically described in the MUTCD.

Background: For many years, some engineers have had concerns that drivers turning left on a permissive circular green signal indication might inadvertently mistake that indication as implying the left turn has the right of way over opposing traffic, especially under some geometric conditions. A variety of different indications and signal face arrangements for permissive left turns have been tried over the years by road authorities, but no comprehensive research had been conducted to evaluate all the potential displays.

Research on the Flashing Yellow Arrow: National Cooperative Highway Research Program (NCHRP) Project 3-54, Evaluation of Traffic Signal Displays for Protected/Permissive Left-Turn Control, was initiated in the mid-1990s for the purpose of conducting the necessary definitive research to evaluate the wide variety of potential displays for permissive left-turn movements. Over a 7-year period, a very comprehensive research process was conducted, including engineering analyses, static and video-based driver comprehension studies, field implementation, video conflict studies, and crash analyses. In 2003, the completed research was published as NCHRP Report 493. The full report may be accessed via the Interim Approvals page of the MUTCD website at <http://mutcd.fhwa.dot.gov>. Key findings of the research include:

- The FYA was found to be the best overall alternative to the circular green as the permissive signal display for a left-turn movement.
- FYA was found to have a high level of understanding and correct response by left-turn drivers, and a lower fail-critical rate than the circular green.



- The FYA display in a separate signal face for the left-turn movement offers more versatility in field application. It is capable of being operated in any of the various modes of left-turn operation by time of day, and is easily programmed to avoid the "yellow trap" associated with some permissive turns at the end of the circular green display.

The NCHRP Report 493 recommends that the FYA be allowed as an alternative to the circular green for permissive left-turn intervals. It also recommends certain specific signal face arrangements and locations, based on driver understanding and performance.

Subsequent to the publication of the NCHRP research, FHWA has approved additional experimentation with the FYA by numerous jurisdictions. Although these experimentations are still in progress, initial results have been positive and supportive of the NCHRP research findings.

FHWA Evaluation of Results: The Office of Transportation Operations has reviewed the research and subsequent additional experimentation and considers the FYA to be successful. Motorists responded strongly and favorably to the concept with little or no public information; these highway users intuitively knew what the flashing yellow arrow meant. The FHWA believes that the FYA has a low risk of safety or operational concerns. Further, the optional use of the FYA provides safety and operational benefits that merit earlier implementation by agencies that wish to use it, pending official MUTCD rulemaking. FYA provides the ability to easily implement lead-lag left-turn phasing and/or variable phasing by time of day, without revising signal hardware and without creating the "left-turn yellow trap" that can occur with the traditional circular green display. Discussions at recent meetings of the National Committee on Uniform Traffic Control Devices (NCUTCD) indicate a consensus in the practitioner community in support of optional use of the FYA. There is a low risk of negative reactions by industry or specific manufacturers or suppliers, and FHWA does not perceive any adverse financial impacts. All existing signal manufacturers make standard signal faces capable of displaying the FYA for left-turn sequences. This Interim Approval does not create a new mandate compelling installation of the FYA for left turns, but for those agencies that do wish to use FYA, it is a low-cost measure to implement.

Conditions of Interim Approval: Interim Approval for the optional use of the FYA for a permissive left-turn indication will be granted to any jurisdiction that submits a written request to the Office of Transportation Operations. A State may request Interim Approval for all jurisdictions in that State. Jurisdictions using FYA under this Interim Approval must agree to maintain an inventory list of all locations where the devices are placed and to comply with Item F at the bottom of Page 1A-6 of the 2003 MUTCD, Section 1A.10 which requires: "An agreement to restore the site(s) of the Interim Approval to a condition that complies with the provisions in this Manual within 3 months following the issuance of a Final Rule on this traffic control device. This agreement must also provide that the agency sponsoring the Interim Approval will terminate use of the device or application installed under the Interim Approval at any time that it determines significant safety concerns are directly or indirectly attributable to the device or application. The FHWA's Office of Transportation Operations has the right to terminate the interim approval at any time if there is an indication of safety concerns."

If an agency opts to use FYA under this Interim Approval, the following design and operational requirements shall apply, and shall take precedence over any conflicting provisions of existing Section 4D.06 of the 2003 MUTCD for the approach on which FYA is displayed:

1. Mode(s) of Left-Turn Operation:

- a. The flashing YELLOW ARROW signal indication may be displayed to indicate a permissive left-turn movement in either a protected/permissive mode or a permissive only mode of operation.
- b. It is not necessary that the left-turn mode for an approach always be the same throughout the day. Varying the left-turn mode on an approach among the permissive only and/or the protected/permissive and/or the protected only left-turn modes during different periods of the day is acceptable.

2. Signal Face Arrangement:

- a. At least one separate four-section signal face, in addition to the minimum of two signal faces for other traffic on the approach, shall be provided for the left-turn movement. The separate left-turn signal face shall be capable of displaying, from top to bottom (or left to right in a horizontally-aligned face), the following set of signal indications: Steady left-turn RED ARROW, steady left-turn YELLOW ARROW, flashing left-turn YELLOW ARROW, and steady left-turn GREEN ARROW. If the left-turn movement is always operated in the permissive only mode, a separate three-section face shall be used instead, with the GREEN ARROW signal section omitted.
- b. A CIRCULAR RED may be substituted for the RED ARROW in States where RED ARROWS are not in current use. If CIRCULAR RED is used instead of RED ARROW in the left-turn signal face, and the left-turn signal face sometimes displays a steady CIRCULAR RED signal indication at a time when the signal faces for the adjacent through movement are not displaying steady CIRCULAR RED signal indications, the CIRCULAR RED signal indication in the left-turn signal face shall be shielded, hooded, louvered, positioned, or designed such that it is not readily visible to drivers in the through lane(s) or a LEFT TURN SIGNAL sign (R10-10) shall be installed adjacent to the left-turn signal face.
- c. A dual-arrow signal section (capable of alternating between the display of a steady GREEN ARROW and a flashing YELLOW ARROW signal indication during steady mode operation) may be used to reduce the total number of signal sections to three if physical conditions make it impractical to use a four-section signal face.

3. Signal Face Location: If an exclusive left-turn lane is present on the approach and if a left-turn signal face is mounted over the roadway, that left-turn signal face should be centered over the left-turn lane or the extension thereof. If centering of the overhead left-turn signal face is not practical, it shall not be positioned any further to the right than the lane line (or the extension of the lane line) between the left-turn lane and the adjacent through lane, nor shall it be positioned any further to the left than the left edge of the left-turn lane (or extension thereof.)
4. Signal Displays:
 - a. During a protected left-turn movement, the left-turn signal face shall display only a steady left-turn GREEN ARROW signal indication.
 - b. During a permissive left-turn movement, the left-turn signal face shall display only a flashing left-turn YELLOW ARROW signal indication.
 - c. During a prohibited left-turn movement, the left-turn signal face shall display only a steady left-turn RED ARROW or a steady CIRCULAR RED.
 - d. A steady left-turn YELLOW ARROW signal indication shall be displayed following every steady left-turn GREEN ARROW signal indication.
 - e. A steady left-turn YELLOW ARROW signal indication shall be displayed following the flashing left-turn YELLOW ARROW signal indication if the permissive left-turn movement is being terminated and the left-turn signal face will subsequently display a steady red signal indication. The signal section that displays the steady left-turn YELLOW ARROW signal indication during change intervals shall not be used to display the flashing left-turn YELLOW ARROW signal indication for permissive left turns.
 - f. When a permissive left-turn movement is changing to a protected left-turn movement, a steady left-turn GREEN ARROW signal indication shall be displayed immediately upon termination of the flashing left-turn YELLOW ARROW signal indication. A steady left-turn YELLOW ARROW signal indication shall not be displayed between the display of the flashing left-turn YELLOW ARROW signal indication and the display of the steady left-turn GREEN ARROW signal indication.
 - g. During flashing mode operation (see Section 4D.12), the display of a flashing left-turn YELLOW ARROW signal indication shall be only from the signal section that displays a steady left-turn YELLOW ARROW signal indication during steady mode (stop-and-go) operation.

Any questions concerning this Interim Approval should be directed to Mr. Scott Wainwright at scott.wainwright@fhwa.dot.gov or by telephone at 202-366-0857.

APPENDIX B – CONDITIONS REPORT

CONDITIONS REPORT

Thank you for your assistance in completing the following and submitting to the address above by **Monday, June 26**. This information will be used to evaluate the effectiveness of the flashing yellow arrow (FYA) as a signal phasing scheme.

Contact Information

Agency	Email
Department	Address 1
Title	Address 2
First Name	City
Last Name	State
Phone	Zip
Fax	

General FYA Implementation Details

How many intersections within your jurisdiction have been approved by FHWA for experimentation?

At how many intersections within your jurisdiction has FYA left-turn phasing been implemented?

Please list all intersections *and* corresponding date when FYA left-turn phasing was implemented in the table below.

	Main Street	Cross Street	County	Date Implemented
1				
2				
3				
4				
5				
6				
7				
8				
9				
10				
11				
12				
13				
14				
15				

Please list all intersections. Make additional copies of table, if necessary.

REQUESTED INTERSECTION DATA

Please provide the following for **EACH intersection** implemented with the FYA indication:

1. Please provide a graphical description of the intersection by including as-built drawings and photos of intersection. If not available, please sketch the intersection geometrics below.

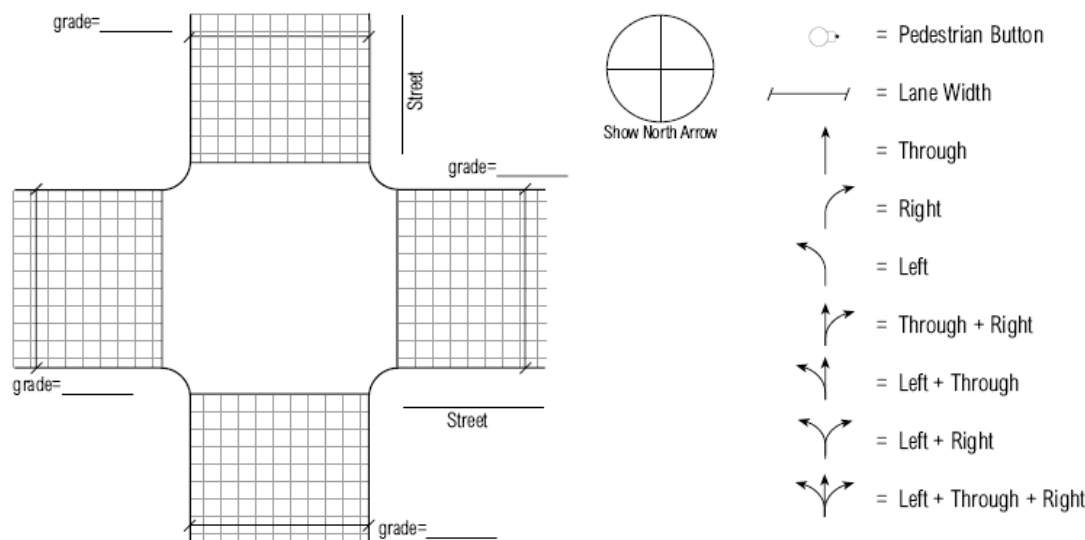

2. Include a minimum of 5 years of traffic volume data for each intersecting street. Volume data should include an estimate of traffic flow both before and after implementation of the FYA indication.
3. Provide crash data at the intersection for a 5-year period prior to implementation of the FYA and for as many years after implementation as available. (Actual police reports are best, if available).
4. Provide crash data for a comparison (control) site that has similar characteristics as the experimental site, but was not implemented with the FYA indication.
5. Attach any operational data available for the intersection.
6. Provide signal timing plans for the intersection before and after implementation of the FYA.
7. Provide controller installation requirements.
8. Provide conflict monitor/MMU requirements.
9. Provide cost estimates for implementation of the FYA at the intersection.

Please contact Casey Bergh at 608-265-8583 with any questions.

APPENDIX C – INTERSECTION INVENTORY OF TREATMENT SITES

El Cajon

Magnolia Avenue/Park Avenue

Intersection ID: 1
 State: CA

N/S Magnolia Avenue
 E/W Park Avenue

Left-Turn Details

Previous Left-turn Control: Protected
 Major Street Speed Limit: 35
 Date Converted to FYA PPLT: 6/29/2005
 FYA Display: 4-section
 Cost Estimation: \$5,000

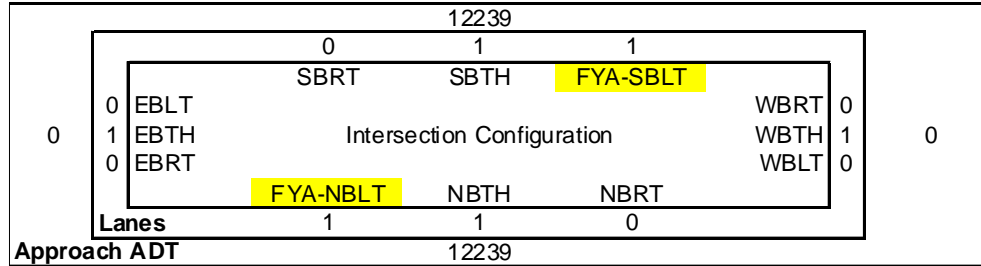

Implementation/Installation Details

Controller: \$170
 Conflict Monitor: Bitrans 233

Crash Data Summary

	Observed/Emperical Data				Target Crash Analysis				
	FYA Approach ADT (Before)	FYA Approach ADT (After)	Observed Before Crashes	Observed After Crashes	Left-turn Crashes (Before)	Left-turn Crashes (After)	FYA Approach LT Crashes (Before)	FYA Approach LT Crashes (After)	
Months of Data (Before/After)	36/24	24478	26349	3.3	4.5	0.7	2.5	0.3	2.0

Comments:

Fullerton Orangethorpe Ave./Lemon St.

Intersection ID: 4 N/S Orangethorpe Avenue
 State: CA E/W Lemon Street

Left-Turn Details

Previous Left-turn Control: Protected
 Major Street Speed Limit: 35
 Date Converted to FYA PPLT: 3/1/2005
 FYA Display: 4-section
 Cost Estimation: \$8,000

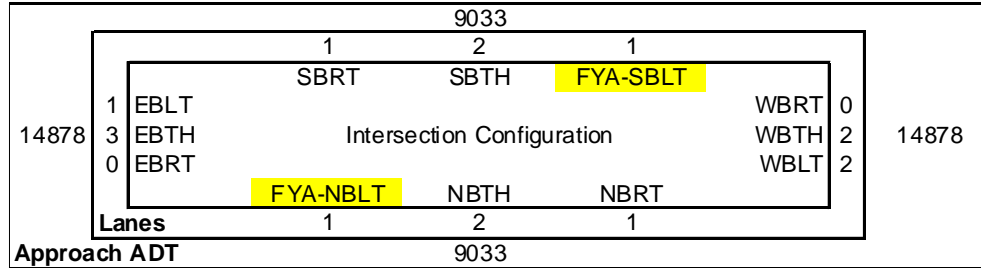

Implementation/Installation Details

Controller: NEMA TS-2
 Conflict Monitor: Eagle M52 (EPAC)

Crash Data Summary

	Observed/Emperical Data			Target Crash Analysis					
	FYA Approach ADT (Before)	FYA Approach ADT (After)	Observed Before Crashes	Observed After Crashes	Left-turn Crashes (Before)	Left-turn Crashes (After)	FYA Approach LT Crashes (Before)	FYA Approach LT Crashes (After)	
Months of Data (Before/After)	60/32	18066	18738	3.2	4.9	1.0	3.0	0.0	1.5

Comments:
 Did not show a significant change in LT volume before and after.

Boulder

Table Mesa Drive/Tantra Drive

Intersection ID: 7
 State: CO

N/S Tantra Drive
 E/W Table Mesa Drive

Left-Turn Details

Previous Left-turn Control: Permitted
 Major Street Speed Limit: 0
 Date Converted to FYA PPLT: 5/19/2004
 FYA Display: 4-section
 Cost Estimation: \$2,800

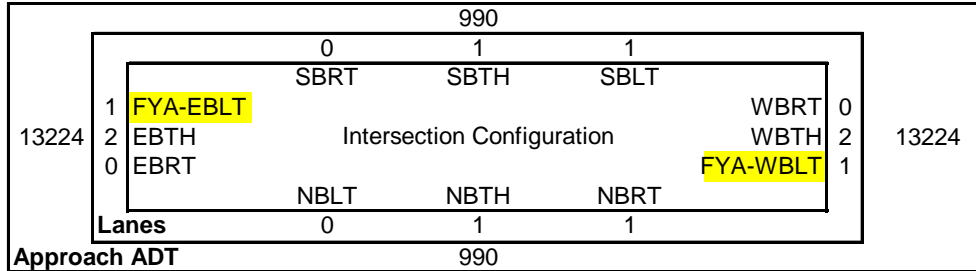

Implementation/Installation Details

Controller: 2070L
 Conflict Monitor: AECOM - Oasis

Crash Data Summary

	Observed/Emperical Data			Target Crash Analysis				
	FYA Approach ADT (Before)	FYA Approach ADT (After)	Observed Before Crashes	Observed After Crashes	Left-turn Crashes (Before)	Left-turn Crashes (After)	FYA Approach LT Crashes (Before)	FYA Approach LT Crashes (After)
Months of Data (Before/After)	60/27	26447 / 26600	6.4	3.6	0.4	N/A	0.4	0.0

Comments:

1 LT crash in 3 years prior to FYA, none in 2 years after.

Traffic conditions required implementation of a protected WBLT during peak hours, but the LT needed to be lagging to avoid corridor progression impacts.

Using a traditional LT would require protected EBLT to avoid LT trap.

At least five reported crashes where driver has observed the adjacent thru indication change to yellow and LT driver thought the permissive phase was ending so they turned left when the opposing lagging SBLT and thru still had green. Louvers were installed on 8/30/06 to address for SB and NB directions.

Livingston Co.

Brighton Rd./Brighton H.S. Entrance

Intersection ID: 28
 State: MI

N/S Brighton H.S. Entrance
 E/W Brighton Road

Left-Turn Details

Previous Left-turn Control: Protected
 Major Street Speed Limit: 35
 Date Converted to FYA PPLT: 7/11/2005
 FYA Display: 4-section
 Cost Estimation: \$5,400

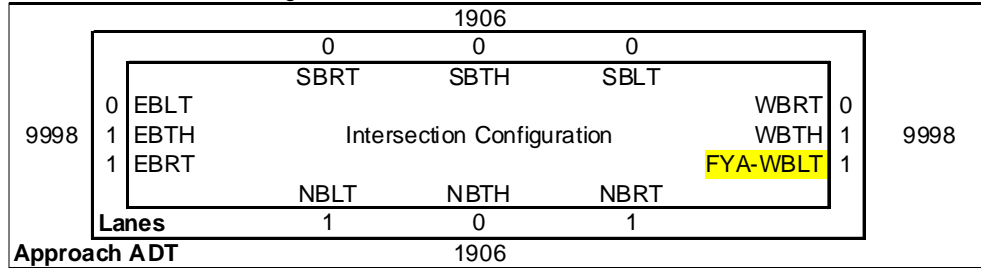

Implementation/Installation Details

Controller: NEMA
 Conflict Monitor: Eagle EPAC

Crash Data Summary

Observed/Emperical Data				Target Crash Analysis				
Months of Data (Before/After)	FYA Approach ADT (Before)	FYA Approach ADT (After)	Observed Before Crashes	Observed After Crashes	Left-turn Crashes (Before)	Left-turn Crashes (After)	FYA Approach LT Crashes (Before)	FYA Approach LT Crashes (After)
72/12	9998	8662	2.0	1.0	0.0	0.0	N/A	N/A

Comments:
 HS approach volume based on ITE trip generation estimate for school.

Livingston Co. Old US-23/Spencer Rd E

Intersection ID: 29
 State: MI

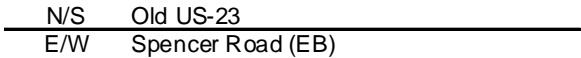

Left-Turn Details

Previous Left-turn Control: Protected
 Major Street Speed Limit: 45
 Date Converted to FYA PPLT: 7/27/2005
 FYA Display: 4-section
 Cost Estimation: \$2,600

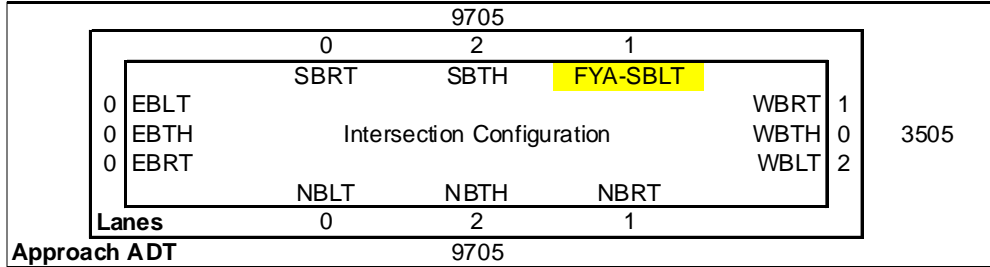

Implementation/Installation Details

Controller: NEMA
 Conflict Monitor: Eagle EPAC

Crash Data Summary

Observed/Emperical Data				Target Crash Analysis				
Months of Data (Before/After)	FYA Approach ADT (Before)	FYA Approach ADT (After)	Observed Before Crashes	Observed After Crashes	Left-turn Crashes (Before)	Left-turn Crashes (After)	FYA Approach LT Crashes (Before)	FYA Approach LT Crashes (After)
72/12	7797	8250	8.166667	4.0	0.0	0.0	N/A	N/A

Comments:
 Crashes at Spencer (E or W) are often confused for one another on crash report.

Livingston Co. Old US-23/Spencer Rd W

Intersection ID: 30
 State: MI

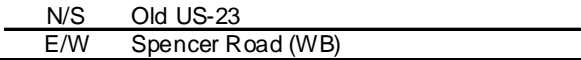

Left-Turn Details

Previous Left-turn Control: Protected
 Major Street Speed Limit: 45
 Date Converted to FYA PPLT: 7/27/2005
 FYA Display: 4-section
 Cost Estimation: \$2,600

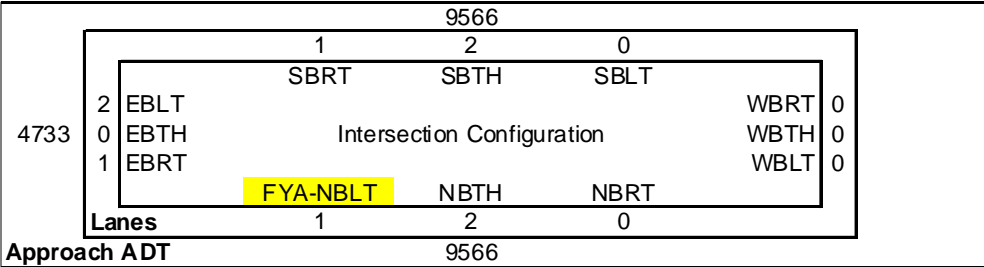

Implementation/Installation Details

Controller: NEMA
 Conflict Monitor: Eagle EPAC

Crash Data Summary

Observed/Emperical Data				Target Crash Analysis				
Months of Data (Before/After)	FYA Approach ADT (Before)	FYA Approach ADT (After)	Observed Before Crashes	Observed After Crashes	Left-turn Crashes (Before)	Left-turn Crashes (After)	FYA Approach LT Crashes (Before)	FYA Approach LT Crashes (After)
72/12	7829	8675	11	7.0	1.3	0.0	N/A	N/A

Comments:
 Crashes at Spencer (E or W) are often confused for one another on crash report.

NCDOT_New Hanover Co US 117 (S. College Rd.)/Big K

Intersection ID: 43
 State: NC

N/S College Road
 E/W Big K/Outlet Driveway

Left-Turn Details

Previous Left-turn Control: PPLT
 Major Street Speed Limit: 45
 Date Converted to FYA PPLT: 11/1/2005
 FYA Display: 4-section
 Cost Estimation: \$0

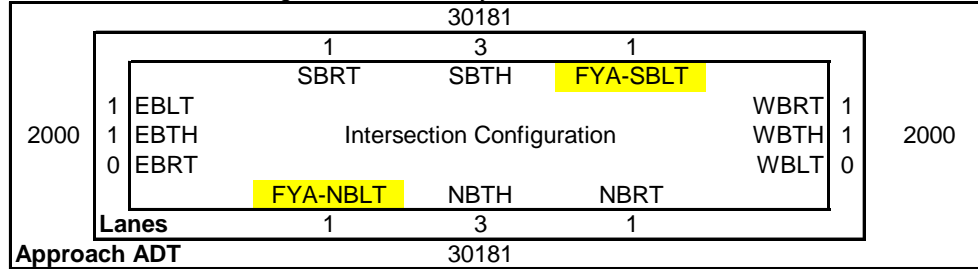

Implementation/Installation Details

Controller: Traconex TMP-390
 Conflict Monitor: NEMA TS-1

Crash Data Summary

Observed/Emperical Data				Target Crash Analysis				
Months of Data (Before/After)	FYA Approach ADT	FYA Approach ADT	Observed Before Crashes	Observed After Crashes	Left-turn Crashes (Before)	Left-turn Crashes (After)	FYA Approach LT	FYA Approach LT
	(Before)	(After)					Crashes (Before)	Crashes (After)
60/12	60361	65916	11.4	8.0	9.2	2.0	9.2	0.0

Comments:

Negative occlusion, estimated to cost \$100,000 to mitigate...FYA was a \$2000 option.
 5-section head

Beaverton 125th Avenue/Longhorn Drive

Intersection ID: 45
 State: OR

N/S 125th Avenue
 E/W Longhorn Lane

Left-Turn Details

Previous Left-turn Control: PPLT
 Major Street Speed Limit: 25
 Date Converted to FYA PPLT: 5/2/2002
 FYA Display: 4-section
 Cost Estimation: \$3,000

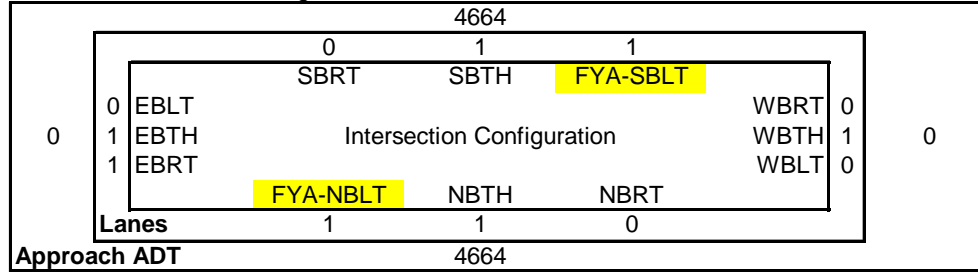

Implementation/Installation Details

Controller: Type 170
 Conflict Monitor: Wapiti

Crash Data Summary

	Observed/Emperical Data			Target Crash Analysis				
	FYA Approach ADT (Before)	FYA Approach ADT (After)	Observed Before Crashes	Observed After Crashes	Left-turn Crashes (Before)	Left-turn Crashes (After)	FYA Approach LT Crashes (Before)	FYA Approach LT Crashes (After)
Months of Data (Before/After)	36/55	9327/9554	1.3	0.4	1.0	N/A	1.0	0.0

Comments:

Assumed to have been implemented with construction at Southridge HS in SW quadrant.

Beaverton

Allen Boulevard/Menlo Drive

Intersection ID: 49
 State: OR

N/S Menlo Drive
 E/W Allen Boulevard

Left-Turn Details

Previous Left-turn Control: PPLT
 Major Street Speed Limit: 25
 Date Converted to FYA PPLT: 4/25/2002
 FYA Display: 4-section
 Cost Estimation: \$3,000

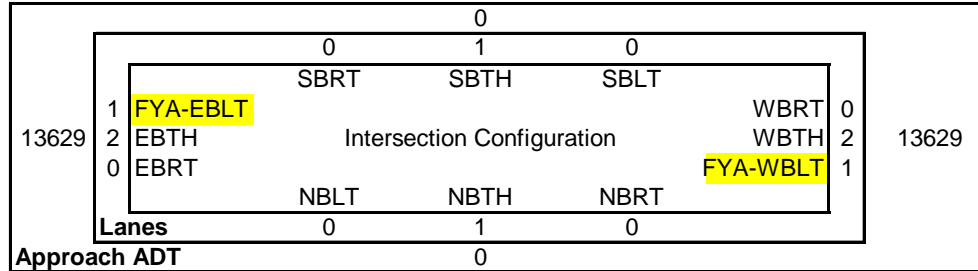

Implementation/Installation Details

Controller: Type 170
 Conflict Monitor: Wapiti

Crash Data Summary

	Observed/Emperical Data			Target Crash Analysis					
	FYA Approach ADT (Before)	FYA Approach ADT (After)	Observed Before Crashes	Observed After Crashes	Left-turn Crashes (Before)	Left-turn Crashes (After)	FYA Approach LT Crashes (Before)	FYA Approach LT Crashes (After)	
Months of Data (Before/After)	36/48	27259	28093	4.0	3.0	2.0	1.0	2.0	1.0

Comments:

Beaverton Allen Boulevard/Wilson Avenue

Intersection ID: 50 N/S Wilson Avenue
 State: OR E/W Allen Boulevard

Left-Turn Details

Previous Left-turn Control: PPLT
 Major Street Speed Limit: 25
 Date Converted to FYA PPLT: 4/23/2002
 FYA Display: 4-section
 Cost Estimation: \$2,000

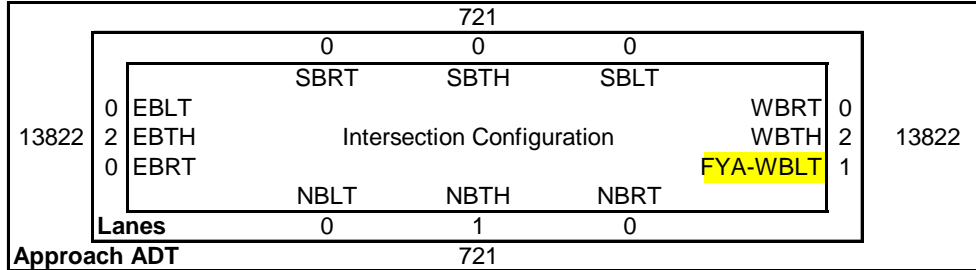

Implementation/Installation Details

Controller: Type 170
 Conflict Monitor: Wapiti

Crash Data Summary

	Observed/Emperical Data			Target Crash Analysis				
	FYA Approach ADT (Before)	FYA Approach ADT (After)	Observed Before Crashes	Observed After Crashes	Left-turn Crashes (Before)	Left-turn Crashes (After)	FYA Approach LT Crashes (Before)	FYA Approach LT Crashes (After)
Months of Data (Before/After)	13394	13943	2.7	1.5	0.3	0.3	0.3	0.0

Comments:
 T-Intersection

Beaverton Beaverton-Hillsdale Highway/Griffith Drive

Intersection ID: 53
 State: OR

N/S Griffith Drive
 E/W Beaverton-Hillsdale Highway

Left-Turn Details

Previous Left-turn Control: Permitted
 Major Street Speed Limit: 25
 Date Converted to FYA PPLT: 11/12/2004
 FYA Display: 4-section
 Cost Estimation: \$30,000

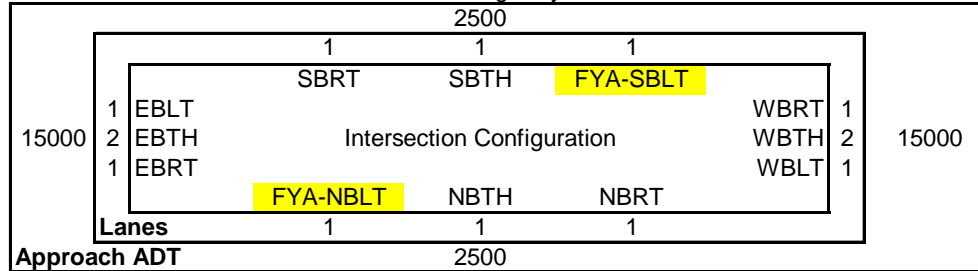

Implementation/Installation Details

Controller: Type 170
 Conflict Monitor: Wapiti

Crash Data Summary

	Observed/Emperical Data				Target Crash Analysis			
	FYA Approach ADT (Before)	FYA Approach ADT (After)	Observed Before Crashes	Observed After Crashes	Left-turn Crashes (Before)	Left-turn Crashes (After)	FYA Approach LT Crashes (Before)	FYA Approach LT Crashes (After)
Months of Data (Before/After)	60/24	5100	5.6	6.5	0.2	0.5	0.2	0.0

Comments:
 Red-light running camera in use!

Beaverton Hall Boulevard/Nimbus Avenue

Intersection ID: 58
 State: OR

N/S Nimbus Avenue
 E/W Hall Boulevard

Left-Turn Details

Previous Left-turn Control: Protected
 Major Street Speed Limit: 35
 Date Converted to FYA PPLT: 5/12/2005
 FYA Display: 4-section
 Cost Estimation: \$2,000

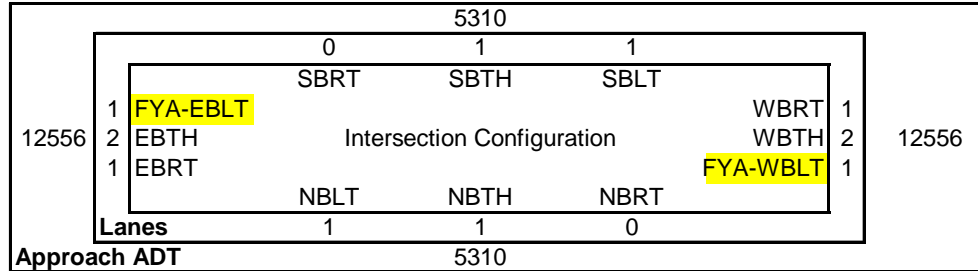

Implementation/Installation Details

Controller: Type 170
 Conflict Monitor: Wapiti

Crash Data Summary

Observed/Emperical Data				Target Crash Analysis				
Months of Data (Before/After)	FYA Approach ADT (Before)	FYA Approach ADT (After)	Observed Before Crashes	Observed After Crashes	Left-turn Crashes (Before)	Left-turn Crashes (After)	FYA Approach LT Crashes (Before)	FYA Approach LT Crashes (After)
60/18	25111	25971	6.4	4.7	2.2	1.3	0.6	0.7

Comments:

Jackson Co. Main/Lozier Lane

Intersection ID: 66
 State: OR

N/S Lozier Lane/Ross Lane
 E/W West Main Street

Left-Turn Details

Previous Left-turn Control: Protected
 Major Street Speed Limit: 35
 Date Converted to FYA PPLT: 4/18/2002
 FYA Display: 3-section
 Cost Estimation: \$0

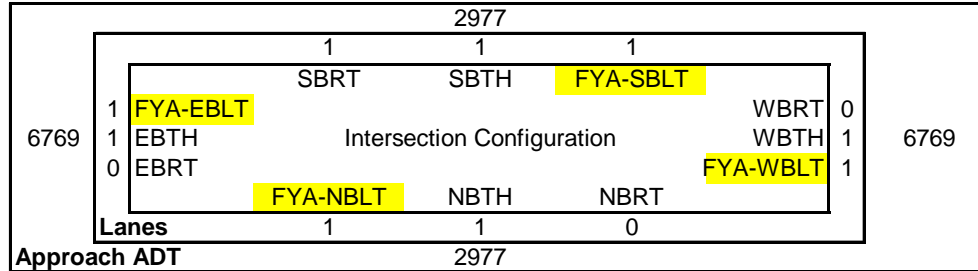

Implementation/Installation Details

Controller: Type 170
 Conflict Monitor: Wapiti

Crash Data Summary

	Observed/Emperical Data				Target Crash Analysis				
	FYA Approach ADT (Before)	FYA Approach ADT (After)	Before Crashes	Observed After Crashes	Left-turn Crashes (Before)	Left-turn Crashes (After)	FYA Approach LT Crashes (Before)	FYA Approach LT Crashes (After)	
Months of Data (Before/After)	60/48	19842	21181	2.6	2.8	N/A	1.5	0.0	1.5

Comments:

Jackson Co. Biddle Road/East Pine Street/Hamrick

Intersection ID: 67
 State: OR

N/S Hamrick Road
 E/W Biddle Road/East Pine Street

Left-Turn Details

Previous Left-turn Control: PPLT
 Major Street Speed Limit: 45
 Date Converted to FYA PPLT: 5/1/2001
 FYA Display: 4-section
 Cost Estimation: \$2,000

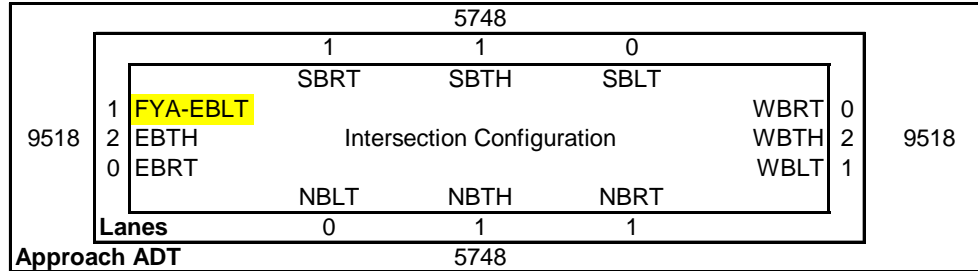

Implementation/Installation Details

Controller: Type 170
 Conflict Monitor: Wapiti

Crash Data Summary

Observed/Emperical Data				Target Crash Analysis				
Months of Data (Before/After)	FYA Approach ADT (Before)	FYA Approach ADT (After)	Observed Before Crashes	Observed After Crashes	Left-turn Crashes (Before)	Left-turn Crashes (After)	FYA Approach LT Crashes (Before)	FYA Approach LT Crashes (After)
60/60	11733	13923	9.4	3.6	6.6	2.6	0.8	0.0

Comments:

EB now using 4-section head, WB continues to use doghouse configuration.

Jackson Co. Pine/NB I-5 Ramp

Intersection ID: 69
 State: OR

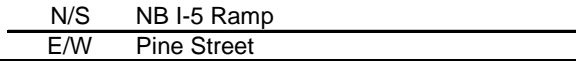

Left-Turn Details

Previous Left-turn Control: Protected
 Major Street Speed Limit: 35
 Date Converted to FYA PPLT: 10/20/2004
 FYA Display: 3-section
 Cost Estimation: \$2,500

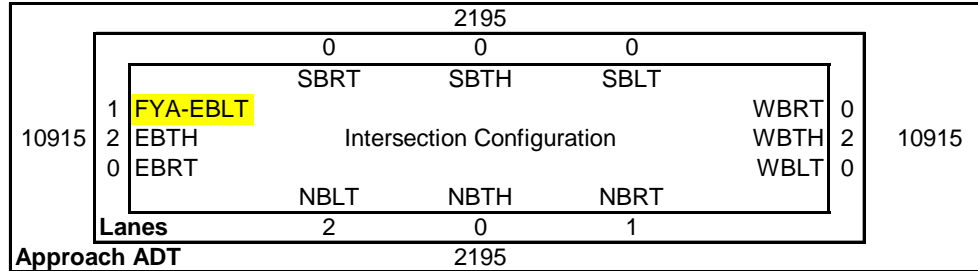

Implementation/Installation Details

Controller: Type 170
 Conflict Monitor: Wapiti

Crash Data Summary

	Observed/Emperical Data				Target Crash Analysis				
	FYA Approach ADT (Before)	FYA Approach ADT (After)	Before Crashes	Observed After Crashes	Left-turn Crashes (Before)	Left-turn Crashes (After)	FYA Approach LT Crashes (Before)	FYA Approach LT Crashes (After)	
Months of Data (Before/After)	72/24	10915	10915	1.0	4.0	0.2	1.0	0.0	0.0

Comments:
 No before count provided.

Jackson Co. Pine/SB I-5 Ramp

Intersection ID: 70
 State: OR

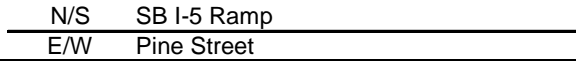

Left-Turn Details

Previous Left-turn Control: Protected
 Major Street Speed Limit: 35
 Date Converted to FYA PPLT: 10/19/2004
 FYA Display: 3-section
 Cost Estimation: \$2,500

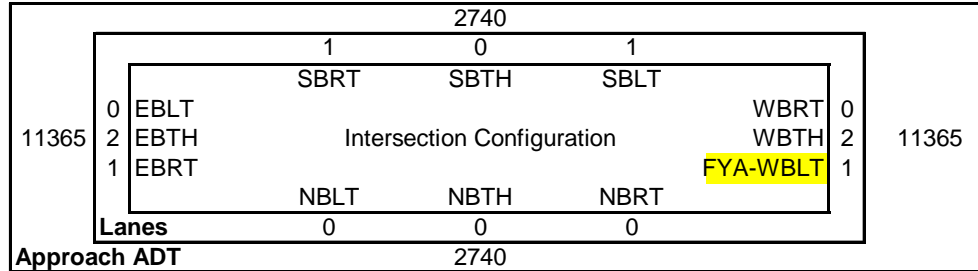

Implementation/Installation Details

Controller: Type 170
 Conflict Monitor: Wapiti

Crash Data Summary

Observed/Emperical Data				Target Crash Analysis				
Months of Data (Before/After)	FYA Approach ADT (Before)	FYA Approach ADT (After)	Observed Before Crashes	Observed After Crashes	Left-turn Crashes (Before)	Left-turn Crashes (After)	FYA Approach LT Crashes (Before)	FYA Approach LT Crashes (After)
72/24	11365	11365	0.8	3.0	N/A	1.0	0.0	0.5

Comments:
 No before count provided.

Jackson Co. Table Rock/Antelope Road

Intersection ID: 72
 State: OR

N/S Table Rock Road
 E/W Antelope Road

Left-Turn Details

Previous Left-turn Control: Protected
 Major Street Speed Limit: 45
 Date Converted to FYA PPLT: 7/13/2001
 FYA Display: 3-section
 Cost Estimation: \$0

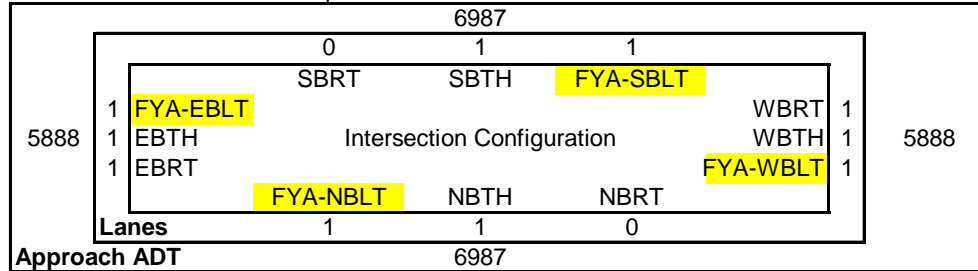

Implementation/Installation Details

Controller: Type 170
 Conflict Monitor: Wapiti

Crash Data Summary

	Observed/Emperical Data			Target Crash Analysis				
	FYA Approach ADT (Before)	FYA Approach ADT (After)	Observed Before Crashes	Observed After Crashes	Left-turn Crashes (Before)	Left-turn Crashes (After)	FYA Approach LT Crashes (Before)	FYA Approach LT Crashes (After)
Months of Data (Before/After)	60/60	25749/28369	1.0	2.0	N/A	1.0	0.0	1.0

Comments:

Jackson Co. Table Rock/Biddle Road

Intersection ID: 73
 State: OR

N/S Table Rock Road
 E/W Biddle Road

Left-Turn Details

Previous Left-turn Control: Protected
 Major Street Speed Limit: 40
 Date Converted to FYA PPLT: 7/9/2001
 FYA Display: 3-section
 Cost Estimation: \$0

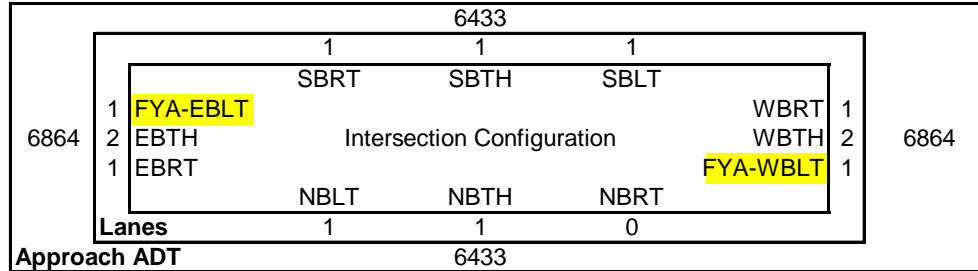

Implementation/Installation Details

Controller: Type 170
 Conflict Monitor: Wapiti

Crash Data Summary

Observed/Emperical Data				Target Crash Analysis				
Months of Data (Before/After)	FYA Approach ADT (Before)	FYA Approach ADT (After)	Observed Before Crashes	Observed After Crashes	Left-turn Crashes (Before)	Left-turn Crashes (After)	FYA Approach LT Crashes (Before)	FYA Approach LT Crashes (After)
60/48	13727	14499	3.4	4.8	0.2	0.8	0.2	0.8

Comments:
 Converted from EB/WB FYA to FYA on all approaches, 10/25/05.
 Initially installed with 3-section FYA.

ODOT_Beaverton ORE 10/107th

Intersection ID: 75
 State: OR

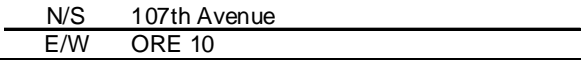

Left-Turn Details

Previous Left-turn Control: Protected
 Major Street Speed Limit: 35
 Date Converted to FYA PPLT: 5/10/2005
 FYA Display: 3-section
 Cost Estimation: \$0

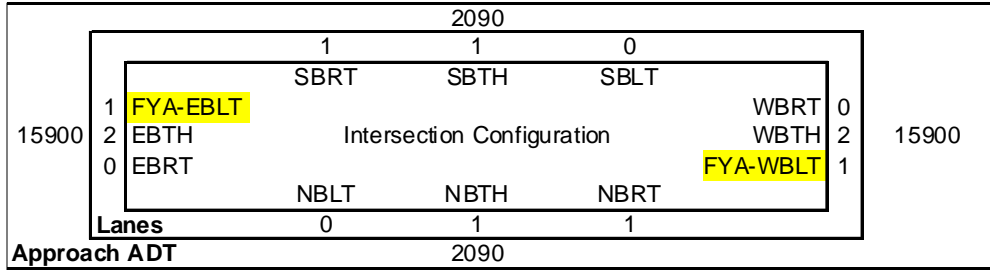

Implementation/Installation Details

Controller: Type 170
 Conflict Monitor: Wapiti

Crash Data Summary

	Observed/Emperical Data			Target Crash Analysis				
	FYA Approach ADT (Before)	FYA Approach ADT (After)	Before Crashes	Observed After Crashes	Left-turn Crashes (Before)	Left-turn Crashes (After)	FYA Approach LT Crashes (Before)	FYA Approach LT Crashes (After)
Months of Data (Before/After)	60/24	31800 / 32000	3.2	9.0	1.2	0.0	0.0	0.0

Comments:
 Part of a corridor with multiple FYA implementations.

ODOT_Beaverton ORE 10/110th

Intersection ID: 76
 State: OR

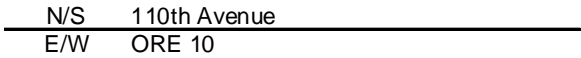

Left-Turn Details

Previous Left-turn Control: Protected
 Major Street Speed Limit: 30
 Date Converted to FYA PPLT: 4/13/2005
 FYA Display: 4-section
 Cost Estimation: \$0

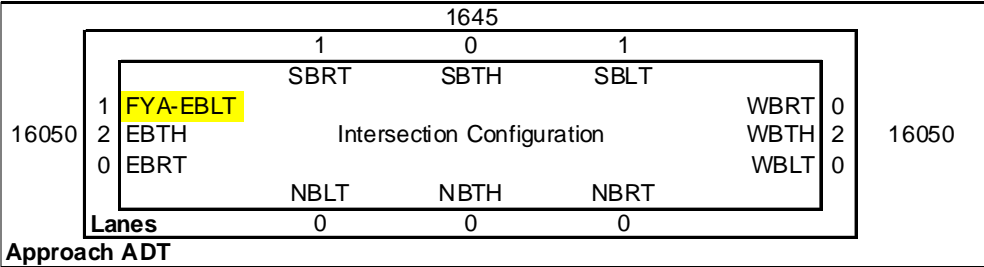

Implementation/Installation Details

Controller: Type 170
 Conflict Monitor: Wapiti

Crash Data Summary

	Observed/Emperical Data			Target Crash Analysis				
	FYA Approach ADT (Before)	FYA Approach ADT (After)	Before Crashes	Observed After Crashes	Left-turn Crashes (Before)	Left-turn Crashes (After)	FYA Approach LT Crashes (Before)	FYA Approach LT Crashes (After)
Months of Data (Before/After)	60/20	32100 / 32300	3.4	6.0	0.2	3.0	0.0	3.0

Comments:
 T-intersection
 Lagging protected LT.
 Part of a corridor with multiple FYA implementations.

ODOT_Beaverton ORE 10/91st

Intersection ID: 78
 State: OR

N/S 91st Avenue
 E/W ORE 10

Left-Turn Details

Previous Left-turn Control: Protected
 Major Street Speed Limit: 35
 Date Converted to FYA PPLT: 5/10/2005
 FYA Display: 4-section
 Cost Estimation: \$0

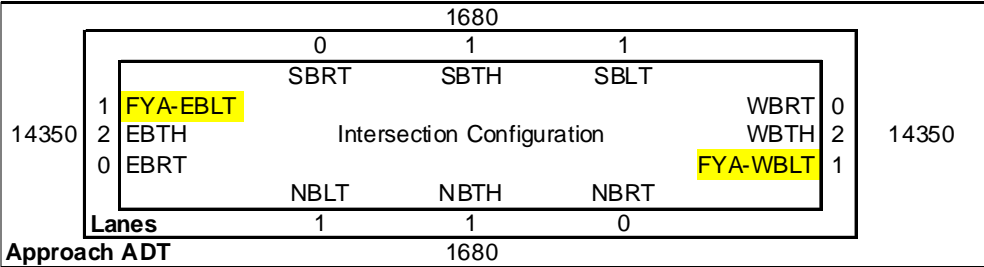

Implementation/Installation Details

Controller: Type 170
 Conflict Monitor: Wapiti

Crash Data Summary

	Observed/Emperical Data			Target Crash Analysis				
	FYA Approach ADT (Before)	FYA Approach ADT (After)	Before Crashes	Observed After Crashes	Left-turn Crashes (Before)	Left-turn Crashes (After)	FYA Approach LT Crashes (Before)	FYA Approach LT Crashes (After)
Months of Data (Before/After)	28700	28900	3.0	4.0	0.2	0.0	0.0	0.0

Comments:
 Part of a corridor with multiple FYA implementations.

ODOT_Beaverton ORE 10/Laurelwood

Intersection ID: 79
 State: OR

N/S Laurelwood Avenue
 E/W ORE 10

Left-Turn Details
 Previous Left-turn Control: Protected
 Major Street Speed Limit: 35
 Date Converted to FYA PPLT: 5/11/2005
 FYA Display: 4-section
 Cost Estimation: \$0

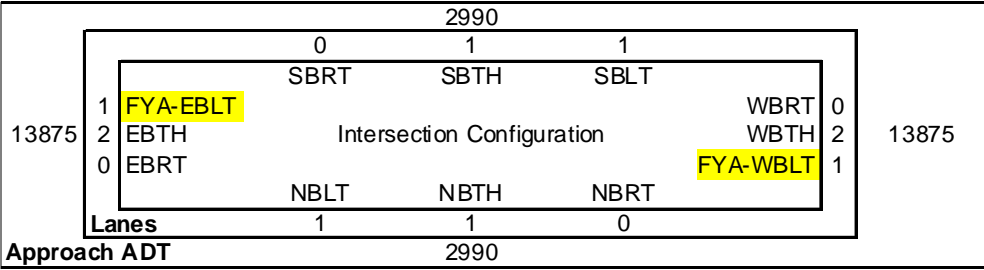

Implementation/Installation Details
 Controller: Type 170
 Conflict Monitor: Wapiti

Crash Data Summary

	Observed/Emperical Data				Target Crash Analysis			
	FYA Approach ADT (Before)	FYA Approach ADT (After)	Before Crashes	Observed After Crashes	Left-turn Crashes (Before)	Left-turn Crashes (After)	FYA Approach LT Crashes (Before)	FYA Approach LT Crashes (After)
Months of Data (Before/After)	27750	27950	11.0	4.0	1.8	0.0	2.0	0.0

Comments:
 Part of a corridor with multiple FYA implementations.

ODOT_Beaverton ORE 10/Western

Intersection ID: 80
 State: OR

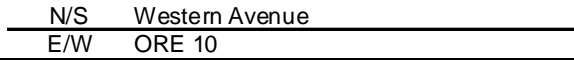

Left-Turn Details

Previous Left-turn Control: Protected
 Major Street Speed Limit: 35
 Date Converted to FYA PPLT: 4/13/2005
 FYA Display: 4-section
 Cost Estimation: \$0

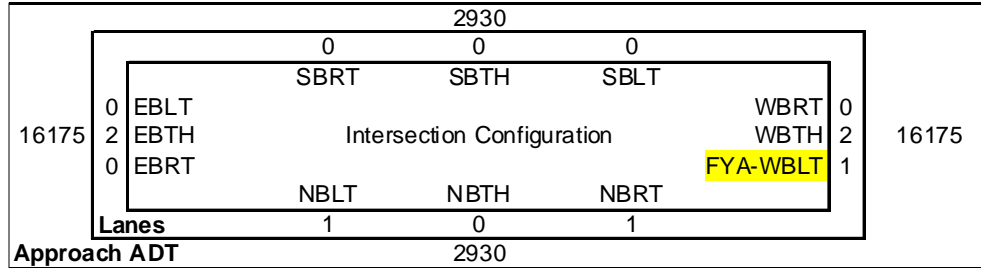

Implementation/Installation Details

Controller: Type 170
 Conflict Monitor: Wapiti

Crash Data Summary

	Observed/Emperical Data			Target Crash Analysis				
	FYA Approach ADT (Before)	FYA Approach ADT (After)	Observed Before Crashes	Observed After Crashes	Left-turn Crashes (Before)	Left-turn Crashes (After)	FYA Approach LT Crashes (Before)	FYA Approach LT Crashes (After)
Months of Data (Before/After)	60/24	32350 / 32600	3.2	4.5	0.4	0.0	0.4	0.0

Comments:
 Part of a corridor with multiple FYA implementations.

ODOT_Beaverton ORE 10/White Pine

Intersection ID: 81
 State: OR

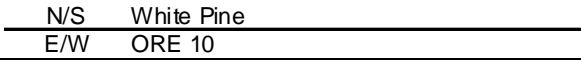

Left-Turn Details

Previous Left-turn Control: PPLT
 Major Street Speed Limit: 35
 Date Converted to FYA PPLT: 5/3/2005
 FYA Display: 4-section
 Cost Estimation: \$0

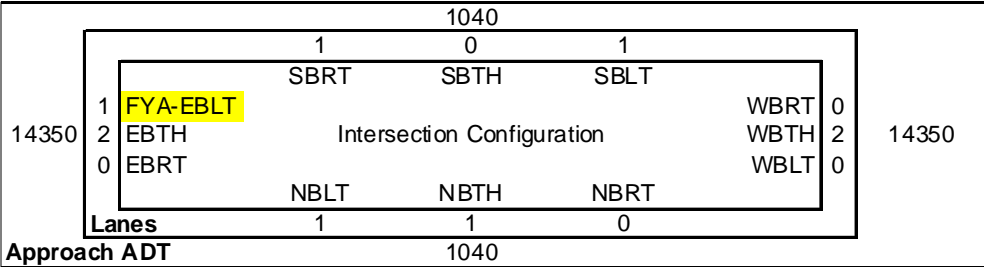

Implementation/Installation Details

Controller: Type 170
 Conflict Monitor: Wapiti

Crash Data Summary

	Observed/Emperical Data			Target Crash Analysis				
	FYA Approach ADT (Before)	FYA Approach ADT (After)	Before Crashes	Observed After Crashes	Left-turn Crashes (Before)	Left-turn Crashes (After)	FYA Approach LT Crashes (Before)	FYA Approach LT Crashes (After)
Months of Data (Before/After)	48/24	28700 / 28900	2.3	1.0	1.3	0.0	0.8	0.0

Comments:
 Part of a corridor with multiple FYA implementations.

ODOT_Portland

N. Hayden Island Drive/Center Street

Intersection ID: 82
 State: OR

N/S Center Street
 E/W Hayden Island Drive

Left-Turn Details

Previous Left-turn Control: Permitted
 Major Street Speed Limit: 30
 Date Converted to FYA PPLT: 8/11/2005
 FYA Display: 4-section
 Cost Estimation: \$0

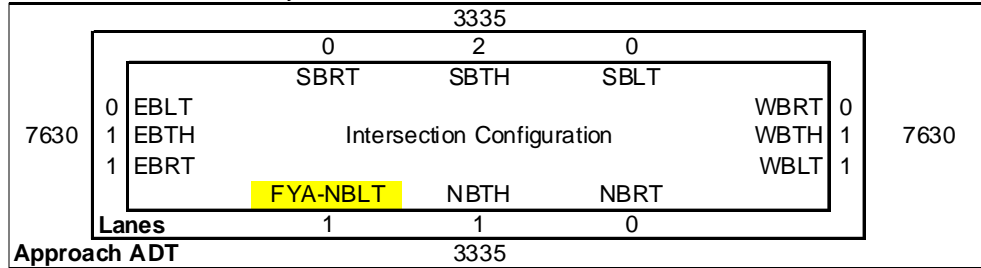

Implementation/Installation Details

Controller: Type 170
 Conflict Monitor: Wapiti

Crash Data Summary

	Observed/Emperical Data				Target Crash Analysis			
	FYA Approach ADT (Before)	FYA Approach ADT (After)	Observed Before Crashes	Observed After Crashes	Left-turn Crashes (Before)	Left-turn Crashes (After)	FYA Approach LT Crashes (Before)	FYA Approach LT Crashes (After)
Months of Data (Before/After)	60/21	5350	0	3.2	1.7	2.0	0.0	0.0

Comments:
 No post-FYA installation approach ADT available.

ODOT_Woodburn ORE 99E/Hardcastle Street

Intersection ID: 85
 State: OR

N/S OR 99E
 E/W Hardcastle Street

Left-Turn Details

Previous Left-turn Control: PPLT
 Major Street Speed Limit: 35
 Date Converted to FYA PPLT: 6/14/2001
 FYA Display: 4-section
 Cost Estimation: \$5,800

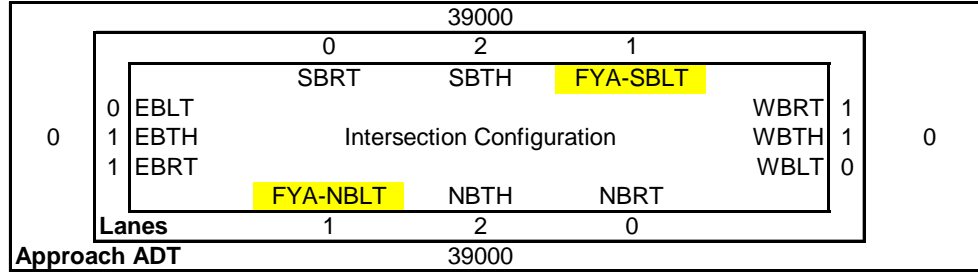

Implementation/Installation Details

Controller: Type 170
 Conflict Monitor: Wapiti

Crash Data Summary

Observed/Emperical Data				Target Crash Analysis				
Months of Data (Before/After)	FYA Approach ADT (Before)	FYA Approach ADT (After)	Observed Before Crashes	Observed After Crashes	Left-turn Crashes (Before)	Left-turn Crashes (After)	FYA Approach LT Crashes (Before)	FYA Approach LT Crashes (After)
24/54	78000	83400	5.5	3.1	1.0	0.2	0.5	0.2

Comments:

Part of original experimental study with NCHRP 3-54.

ODOT_Woodburn ORE 99E/Lincoln Street

Intersection ID: 86
 State: OR

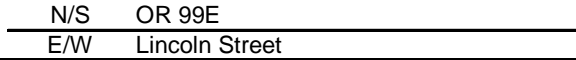

Left-Turn Details

Previous Left-turn Control: PPLT
 Major Street Speed Limit: 35
 Date Converted to FYA PPLT: 6/14/2001
 FYA Display: 4-section
 Cost Estimation: \$5,800

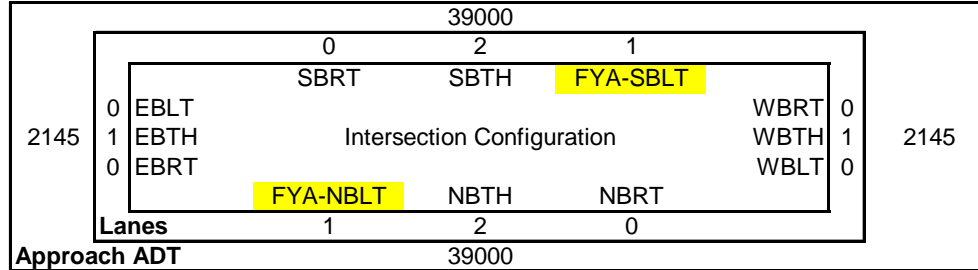

Implementation/Installation Details

Controller: Type 170
 Conflict Monitor: Wapiti

Crash Data Summary

Observed/Emperical Data				Target Crash Analysis				
Months of Data (Before/After)	FYA Approach ADT (Before)	FYA Approach ADT (After)	Observed Before Crashes	Observed After Crashes	Left-turn Crashes (Before)	Left-turn Crashes (After)	FYA Approach LT Crashes (Before)	FYA Approach LT Crashes (After)
24/48	78000	83400	2.5	1.0	1.0	0.3	1.0	0.3

Comments:
 Part of original experimental study with NCHRP 3-54.

ODOT_Sandy US 26/ORE 211

Intersection ID: 87
 State: OR

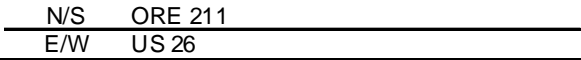

Left-Turn Details

Previous Left-turn Control: Permitted
 Major Street Speed Limit: 25
 Date Converted to FYA PPLT: 8/24/2005
 FYA Display: 4-section
 Cost Estimation: \$0

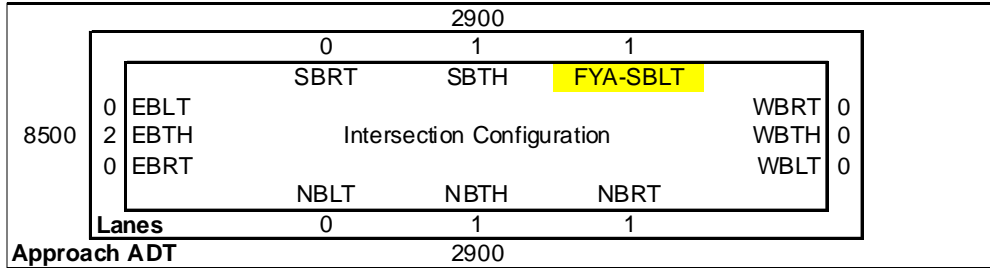

Implementation/Installation Details

Controller: Type 170
 Conflict Monitor: Wapiti

Crash Data Summary

	Observed/Emperical Data			Target Crash Analysis					
	FYA Approach ADT (Before)	FYA Approach ADT (After)	Before Crashes	Observed After Crashes	Left-turn Crashes (Before)	Left-turn Crashes (After)	FYA Approach LT Crashes (Before)	FYA Approach LT Crashes (After)	
Months of Data (Before/After)	60/20	1600	0	1.4	1.8	0.2	0.0	0.2	0.0

Comments:

ORE 211 is a one-way street.
 No post-FYA installation approach ADT available.

Alexandria Duke Street/4600/Fox Chase

Intersection ID: 92 N/S Foxchase Shopping Center/4600
 State: VA E/W Duke Street

Left-Turn Details

Previous Left-turn Control: PPLT
 Major Street Speed Limit: 35
 Date Converted to FYA PPLT: 11/16/2004
 FYA Display: 4-section
 Cost Estimation: \$10,000

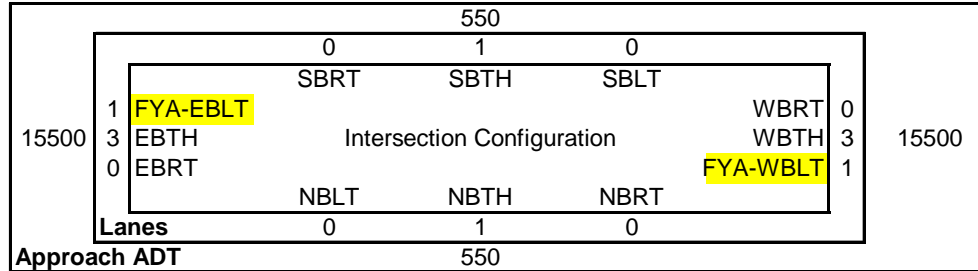

Implementation/Installation Details

Controller: \$0
 Conflict Monitor: 0

Crash Data Summary

Observed/Emperical Data				Target Crash Analysis				
Months of Data (Before/After)	FYA Approach ADT (Before)	FYA Approach ADT (After)	Observed Before Crashes	Observed After Crashes	Left-turn Crashes (Before)	Left-turn Crashes (After)	FYA Approach LT Crashes (Before)	FYA Approach LT Crashes (After)
36/24	31000	31000	6.3	4.0	1.3	1.0	1.3	1.0

Comments:

Alexandria Duke Street/Jordan Street

Intersection ID: 93
 State: VA

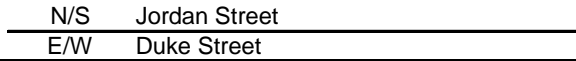

Left-Turn Details

Previous Left-turn Control: PPLT
 Major Street Speed Limit: 35
 Date Converted to FYA PPLT: 9/21/2004
 FYA Display: 4-section
 Cost Estimation: \$7,000

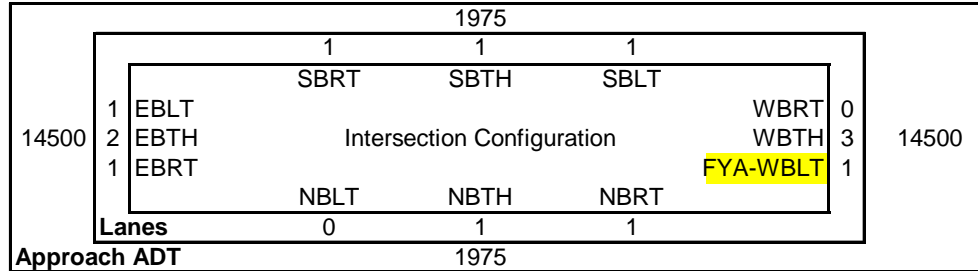

Implementation/Installation Details

Controller: \$0
 Conflict Monitor: 0

Crash Data Summary

Observed/Emperical Data				Target Crash Analysis				
Months of Data (Before/After)	FYA Approach ADT (Before)	FYA Approach ADT (After)	Observed Before Crashes	Observed After Crashes	Left-turn Crashes (Before)	Left-turn Crashes (After)	FYA Approach LT Crashes (Before)	FYA Approach LT Crashes (After)
36/24	14500	14500	5.7	3.0	0.3	N/A	0.0	0.0

Comments:

Lacey Mullen Road/Ruddell Road

Intersection ID: 98
 State: WA

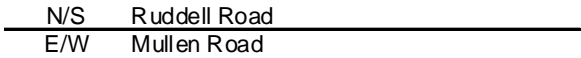

Left-Turn Details

Previous Left-turn Control: PPLT
 Major Street Speed Limit: 35
 Date Converted to FYA PPLT: 3/9/2005
 FYA Display: 4-section
 Cost Estimation: \$0

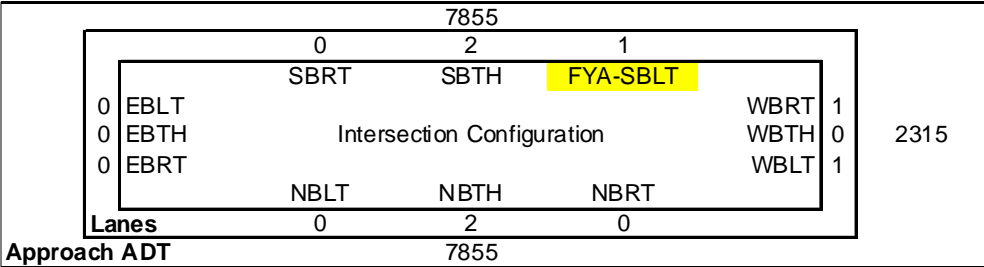

Implementation/Installation Details

Controller: NEMA
 Conflict Monitor: Traconex

Crash Data Summary

	Observed/Emperical Data				Target Crash Analysis			
	FYA Approach ADT (Before)	FYA Approach ADT (After)	Before Crashes	Observed After Crashes	Left-turn Crashes (Before)	Left-turn Crashes (After)	FYA Approach LT Crashes (Before)	FYA Approach LT Crashes (After)
Months of Data (Before/After)	36/36	9100/8103	8.0	5.3	4.0	1.7	4.0	1.7

Comments:
 T-Intersection, will be 4-way in future.

Snohomish Co. 128th St SW & 8th Avenue

Intersection ID: 99
 State: WA

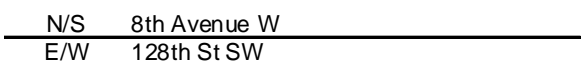

Left-Turn Details

Previous Left-turn Control: Protected
 Major Street Speed Limit: 35
 Date Converted to FYA PPLT: 11/16/2005
 FYA Display: 4-section
 Cost Estimation: \$0

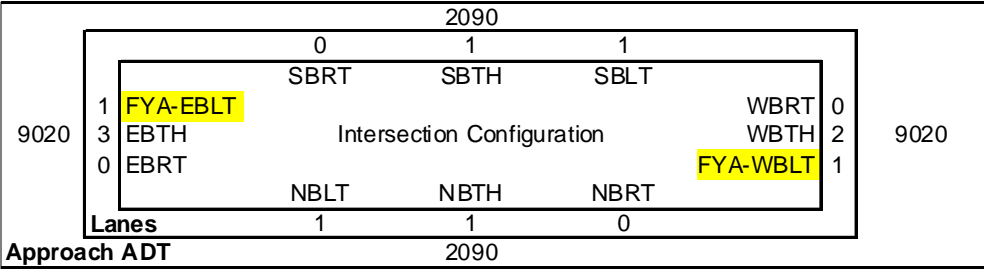

Implementation/Installation Details

Controller: Type 170
 Conflict Monitor: Bi-Trans 233 (210 ECL)

Crash Data Summary

	Observed/Emperical Data			Target Crash Analysis				
	FYA Approach ADT (Before)	FYA Approach ADT (After)	Before Crashes	Observed After Crashes	Left-turn Crashes (Before)	Left-turn Crashes (After)	FYA Approach LT Crashes (Before)	FYA Approach LT Crashes (After)
Months of Data (Before/After)	18040	19760	6.4	15.2	0.8	6.9	0.8	13.9

Comments:
 Was protected only, converted to PPLT 5/1 1/05

Snohomish Co. 128th St. SW & 5th Place West

Intersection ID: 100
 State: WA

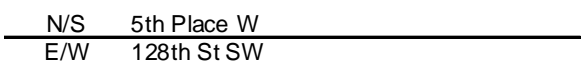

Left-Turn Details

Previous Left-turn Control: PPLT
 Major Street Speed Limit: 35
 Date Converted to FYA PPLT: 5/11/2005
 FYA Display: 4-section
 Cost Estimation: \$0

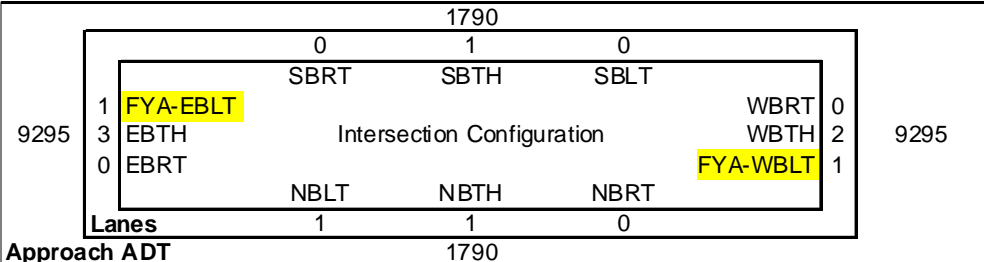

Implementation/Installation Details

Controller: Type 170
 Conflict Monitor: Bi-Trans 233 (210 ECL)

Crash Data Summary

	Observed/Emperical Data				Target Crash Analysis			
	FYA Approach ADT (Before)	FYA Approach ADT (After)	Before Crashes	Observed After Crashes	Left-turn Crashes (Before)	Left-turn Crashes (After)	FYA Approach LT Crashes (Before)	FYA Approach LT Crashes (After)
Months of Data (Before/After)	18590	20110	8.4	11.1	4.2	5.1	4.2	21.0

Comments:

Snohomish Co.

164th St SE & 9th Ave/Main/Mill

Intersection ID: 101
 State: WA

N/S Mill Creek Boulevard/9th Avenue SE
 E/W 164th Street SE

Left-Turn Details

Previous Left-turn Control: PPLT
 Major Street Speed Limit: 35
 Date Converted to FYA PPLT: 1/28/2005
 FYA Display: 4-section
 Cost Estimation: \$0

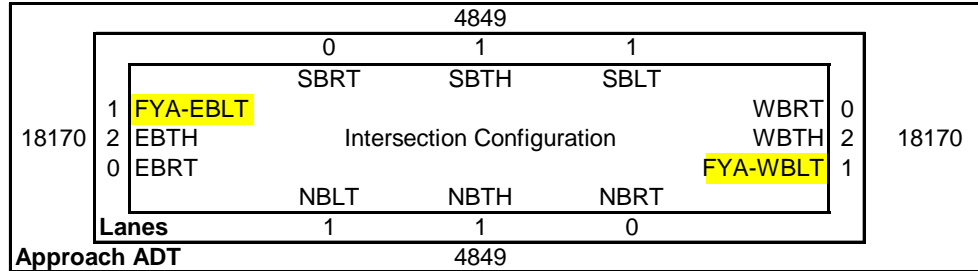

Implementation/Installation Details

Controller: Type 170
 Conflict Monitor: Bi-Trans 233 (210 ECL)

Crash Data Summary

	Observed/Emperical Data				Target Crash Analysis				
	FYA Approach ADT (Before)	FYA Approach ADT (After)	Observed Before Crashes	Observed After Crashes	Left-turn Crashes (Before)	Left-turn Crashes (After)	FYA Approach LT Crashes (Before)	FYA Approach LT Crashes (After)	
Months of Data (Before/After)	22/21	36341	37890	18.5	15.4	15.3	10.3	N/A	N/A

Comments:

Snohomish Co. Airport Road & Admiralty Way

Intersection ID: 103
 State: WA

N/S Airport Road
 E/W Admiralty Way

Left-Turn Details

Previous Left-turn Control: Protected
 Major Street Speed Limit: 45
 Date Converted to FYA PPLT: 10/19/2005
 FYA Display: 3-section
 Cost Estimation: \$0

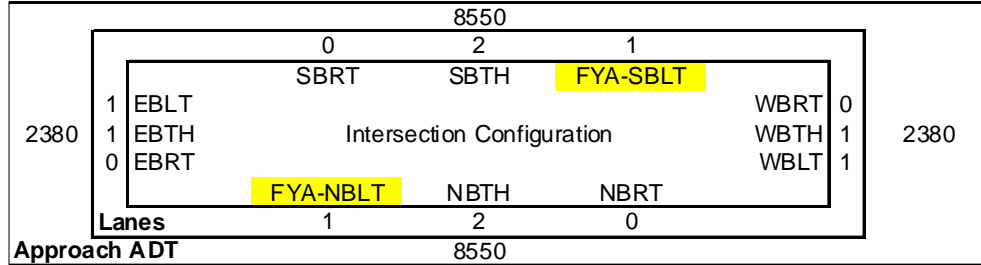

Implementation/Installation Details

Controller: Type 170
 Conflict Monitor: Bi-Trans 233 (210 ECL)

Crash Data Summary

	Observed/Emperical Data			Target Crash Analysis				
	FYA Approach ADT (Before)	FYA Approach ADT (After)	Before Crashes	Observed After Crashes	Left-turn Crashes (Before)	Left-turn Crashes (After)	FYA Approach LT Crashes (Before)	FYA Approach LT Crashes (After)
Months of Data (Before/After)	6/21	17/10	9.0	10.9	0.6	1.0	0.2	0.0

Comments:

Snohomish Co.

Airport Road & Gibson Road

Intersection ID: 104
 State: WA

N/S E Gibson Road
 E/W 128th Avenue SW/Airport Road

Left-Turn Details

Previous Left-turn Control: Protected
 Major Street Speed Limit: 45
 Date Converted to FYA PPLT: 11/2/2005
 FYA Display: 3-section
 Cost Estimation: \$0

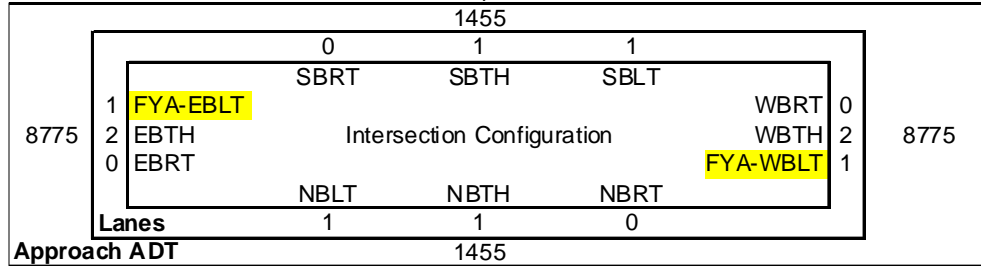

Implementation/Installation Details

Controller: Type 170
 Conflict Monitor: Bi-Trans 233 (210 ECL)

Crash Data Summary

	Observed/Emperical Data			Target Crash Analysis					
	FYA Approach ADT (Before)	FYA Approach ADT (After)	Before Crashes	Observed After Crashes	Left-turn Crashes (Before)	Left-turn Crashes (After)	FYA Approach LT Crashes (Before)	FYA Approach LT Crashes (After)	
Months of Data (Before/After)	60/20	17550	18230	6.4	10.8	1.0	6.0	0.6	3.6

Comments:

APPENDIX D – TRAFFIC VOLUME SUMMARY TABLES

ID	Intersection	Location	LT Product		FYA Approach ADT		TEV		Major ADT		Minor ADT	
			Before	After	Before	After	Before	After	Before	After	Before	After
			Group A: Converted from Protected/Permitted Left-turn Control									
43	US 117 (S. College Rd.)/Big K	NCDOT_Harnett Co., NC	-	-	60361	79416	42000	45900	60361	79416	-	-
45	125th Avenue/Longhorn Drive	Beaverton, OR	-	-	8890	9554	-	-	-	-	-	-
49	Allen Boulevard/Menlo Drive	Beaverton, OR	-	-	27259	28093	27259	29923	27259	28093	-	1830
50	Allen Boulevard/Wilson Avenue	Beaverton, OR	-	-	13394	13943	29088	30281	27645	28779	1443	1502
67	Pine(Biddle)/Hamrick (EB)	Jackson Co., OR	-	159962	11733	13923	31037	34111	19035	21299	11496	14900
81	Beaverton-Hillsdale Hwy/White Pine	ODOT, OR	65650	-	28700	28900	30780	30980	28700	28900	2080	2080
85	ORE 99E/Hardcastle (N/S)	ODOT, OR	74603	-	78000	83400	-	-	78000	83400	-	-
86	ORE 99E/Lincoln (N/S)	ODOT, OR	-	113875	78000	83400	82290	86700	78000	83400	4290	3300
92	Duke Street/4600/Fox Chase	Alexandria, VA	-	-	31000	31000	32100	32100	31000	31000	1100	1100
93	Duke Street/Jordan Street	Alexandria, VA	-	-	14500	14500	18450	18450	14500	14500	3950	3950
98	Mullen Road/Ruddell Road	Lacey, WA	76560	63426	9100	8103	20340	21264	15710	16634	4630	4630
100	128th St. SW & 5th Place West (E/W)	Snohomish Co., WA	55278	63074	18590	20110	22170	23690	18590	20110	3580	3580
101	164th St SE & 9th Ave/Main/Mill (E/W)	Snohomish Co., WA	-	-	36341	37890	46039	47588	36341	37890	9698	9698
Group B: Converted from Protected Left-turn Control												
1	Magnolia Avenue/Park Avenue	El Cajon, CA	-	-	24478	26349	-	-	24478	26349	-	-
4	Orangethorpe Ave./Lemon St.	Fullerton, CA	166335	173220	17000	20000	45000	49000	28000	29000	17000	20000
28	Brighton Rd./Brighton H.S. Entrance	Livingston Co., MI	-	-	-	-	-	-	19995	19995	-	-
29	Old US-23/Spencer Rd E (7.909)	Livingston Co., MI	-	-	7420	8156	25349	27864	18339	20158	7011	7706
30	Old US-23/Spencer Rd W (NB US-23)	Livingston Co., MI	-	-	7829	8675	30350	32657	21838	23225	8512	9432
58	Hall Boulevard/Nimbus Avenue	Beaverton, OR	-	-	-	-	34900	37333	24280	25681	10620	11652
66	Main/Lozier Lane	Jackson Co., OR	-	218589	18984	22160	18984	22160	13539	13090	5953	10350
69	Pine/NB I-5 Ramp (EB Only)	Jackson Co., OR	-	-	10915	10915	26220	26260	21830	21830	4390	4430
70	Pine/SB I-5 Ramp (WB Only)	Jackson Co., OR	-	-	11365	11365	28210	28290	22730	22730	5480	5560
72	Table Rock/Antelope	Jackson Co., OR	-	74167	25749	28369	25749	28369	13974	15081	11775	13288
73	Table Rock/Biddle (EB/WB)	Jackson Co., OR	-	-	13727	13820	26593	29121	13727	13820	12866	15301
75	Beaverton-Hillsdale Hwy/107th	ODOT, OR	64484	-	31800	32000	35980	36180	31800	32000	4180	4180
76	Beaverton-Hillsdale Hwy/110th	ODOT, OR	116982	-	32100	32300	35390	35590	32100	32300	3290	3290
78	Beaverton-Hillsdale Hwy/91st	ODOT, OR	108261	-	28700	28900	32060	32260	28700	28900	3360	3360
79	Beaverton-Hillsdale Hwy/Laurelwood	ODOT, OR	85431	-	27750	27950	32550	33930	27750	27950	5980	5980
80	Beaverton-Hillsdale Hwy/Western	ODOT, OR	194531	-	32350	32600	5860	38460	32350	32600	5860	5860
103	Airport Road & Admiralty Way	Snohomish Co., WA	54271	63586	17100	19130	21860	23030	17100	19130	4760	4760
104	Airport Road & Gibson Road	Snohomish Co., WA	54531	74674	17550	18230	20460	21560	17550	18230	2910	3330
Group C: Converted from Permitted Left-turn Control												
7	Table Mesa Drive/Tantra Drive	Boulder, CO	-	-	26096	26000	28076	28580	26096	26600	1980	1980
53	Beaverton-Hillsdale Highway/Griffith Drive	Beaverton, OR	-	-	5000	5100	35000	35700	30000	30600	5000	5100
82	N. Hayden Island Drive/Center Street	ODOT, OR	13860	-	5350	-	-	-	15260	-	6670	-
87	US 26/ORE 211	ODOT, OR	8400	-	1600	-	22800	-	17000	-	5800	-

APPENDIX E – INTERSECTION INVENTORY OF COMPARISON SITES

Fullerton

Associated Rd/Bastanchury Road

Intersection ID: 107
 State: CA

N/S Associated Road
 E/W Bastanchury Road

Left-Turn Details

Previous Left-turn Control: Control
 Major Street Speed Limit: 40
 Date Converted to FYA PPLT: Control
 FYA Display: Control
 Cost Estimation: \$0

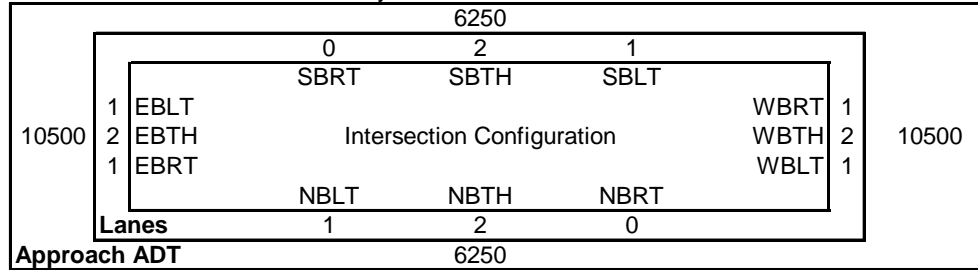

Implementation/Installation Details

Controller
 Conflict Monitor

Crash Data Summary

Observed/Emperical Data				Target Crash Analysis				
Months of Data (Before/After)	Approach ADT (Before)	Approach ADT (After)	Observed Before Crashes	Observed After Crashes	Left-turn Crashes (Before)	Left-turn Crashes (After)	Approach LT Crashes (Before)	Approach LT Crashes (After)
60/19	12500	12500	6.4	8.2	1.6	5.7	0.6	5.7

Comments:
 Control Site

Fullerton

Commonwealth Avenue/Harbor Road

Intersection ID: 108
 State: CA

N/S Harbor Boulevard
 E/W Commonwealth Avenue

Left-Turn Details

Previous Left-turn Control: PPLT
 Major Street Speed Limit: 40
 Date Converted to FYA PPLT: Control
 FYA Display: Control
 Cost Estimation: \$0

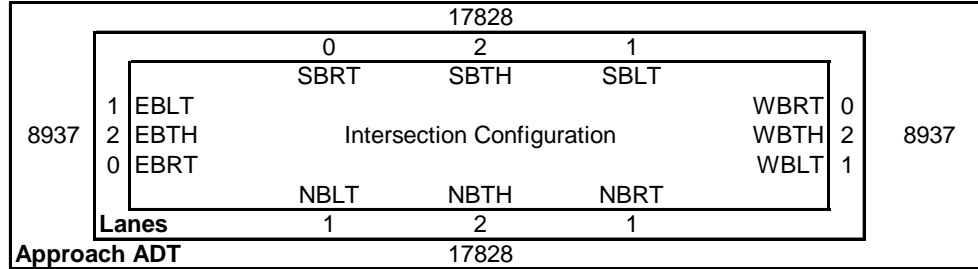

Implementation/Installation Details

Controller
 Conflict Monitor

Crash Data Summary

Observed/Emperical Data				Target Crash Analysis				
Months of Data (Before/After)	Approach ADT (Before)	Approach ADT (After)	Observed Before Crashes	Observed After Crashes	Left-turn Crashes (Before)	Left-turn Crashes (After)	Approach LT Crashes (Before)	Approach LT Crashes (After)
60/19	0	0	15.8	3.8	7.6	1.3	4.4	1.3

Comments:
 Control Site
 ADT unavailable

Fullerton

Chapman Avenue/Harbor Boulevard

Intersection ID: 109
 State: CA

N/S Harbor Boulevard
 E/W Chapman Avenue

Left-Turn Details

Previous Left-turn Control: PPLT
 Major Street Speed Limit: 40
 Date Converted to FYA PPLT: Control
 FYA Display: Control
 Cost Estimation: \$0

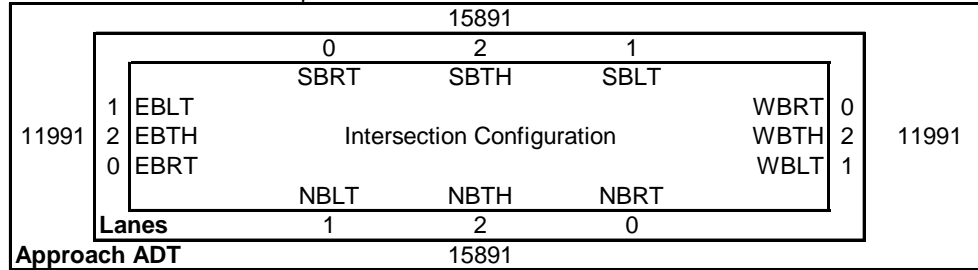

Implementation/Installation Details

Controller
 Conflict Monitor

Crash Data Summary

Observed/Emperical Data				Target Crash Analysis				
Months of Data (Before/After)	Approach ADT (Before)	Approach ADT (After)	Observed Before Crashes	Observed After Crashes	Left-turn Crashes (Before)	Left-turn Crashes (After)	Approach LT Crashes (Before)	Approach LT Crashes (After)
60/19	0	0	19	10.1	11.2	6.3	7.2	5.7

Comments:
 Control Site
 ADT unavailable

NCDOT College Road/Hoggard/Hurst

Intersection ID: 116
 State: NC

N/S College Road
 E/W Hoggard Drive/Hurst Drive

Left-Turn Details

Previous Left-turn Control: PPLT
 Major Street Speed Limit: 45
 Date Converted to FYA PPLT: Comparison
 FYA Display: Doghouse
 Cost Estimation: \$0

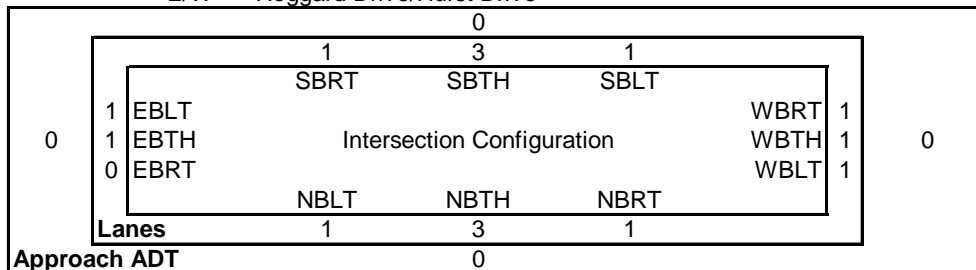

Implementation/Installation Details

Controller
 Conflict Monitor

Crash Data Summary

Observed/Emperical Data				Target Crash Analysis				
Months of Data (Before/After)	Approach ADT (Before)	Approach ADT (After)	Observed Before Crashes	Observed After Crashes	Left-turn Crashes (Before)	Left-turn Crashes (After)	Approach LT Crashes (Before)	Approach LT Crashes (After)
72/8	0	0	16.5	22.5	4.8	7.5	3.8	4.5

Comments:
 PPLT N/S, Permitted E/W
 ADT unavailable

NCDOT College Road/Wilshire

Intersection ID: 117
 State: NC

N/S College Road
 E/W Wilshire Boulevard

Left-Turn Details

Previous Left-turn Control: PPLT
 Major Street Speed Limit: 45
 Date Converted to FYA PPLT: Comparison
 FYA Display: Doghouse
 Cost Estimation: \$0

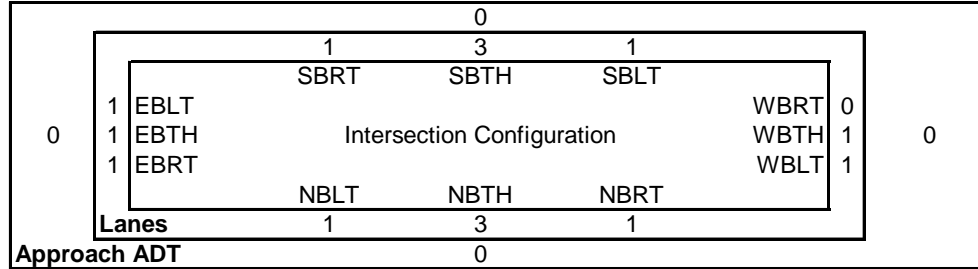

Implementation/Installation Details

Controller
 Conflict Monitor

Crash Data Summary

Observed/Emperical Data				Target Crash Analysis				
Months of Data (Before/After)	Approach ADT (Before)	Approach ADT (After)	Observed Before Crashes	Observed After Crashes	Left-turn Crashes (Before)	Left-turn Crashes (After)	Approach LT Crashes (Before)	Approach LT Crashes (After)
72/8	0	0	18.0	12.0	4.2	4.5	1.3	4.5

Comments:
 Doghouse on major street, 4-section pplt on minor
 ADT unavailable

NCDOT Robeson/Whitfield

Intersection ID: 118
 State: NC

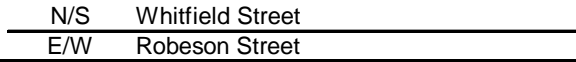

Left-Turn Details

Previous Left-turn Control: PPLT
 Major Street Speed Limit: 45
 Date Converted to FYA PPLT: Comparison
 FYA Display: Doghouse
 Cost Estimation: \$0

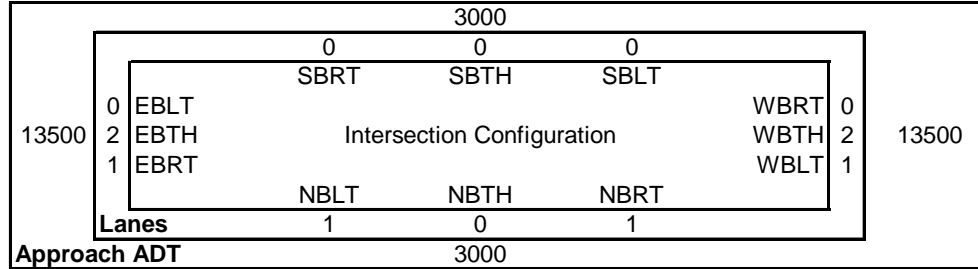

Implementation/Installation Details

Controller
 Conflict Monitor

Crash Data Summary

Observed/Emperical Data				Target Crash Analysis				
Months of Data (Before/After)	Approach ADT (Before)	Approach ADT (After)	Observed Before Crashes	Observed After Crashes	Left-turn Crashes (Before)	Left-turn Crashes (After)	Approach LT Crashes (Before)	Approach LT Crashes (After)
72/8	14000	16000	9.3	3.0	2.3	0.0	1.8	0.0

Comments:

NCDOT Ramsey/Rosehill

Intersection ID: 119
 State: NC

N/S Ramsey Street
 E/W Rosehill Road

Left-Turn Details

Previous Left-turn Control: PPLT
 Major Street Speed Limit: 45
 Date Converted to FYA PPLT: Comparison
 FYA Display: Doghouse
 Cost Estimation: \$0

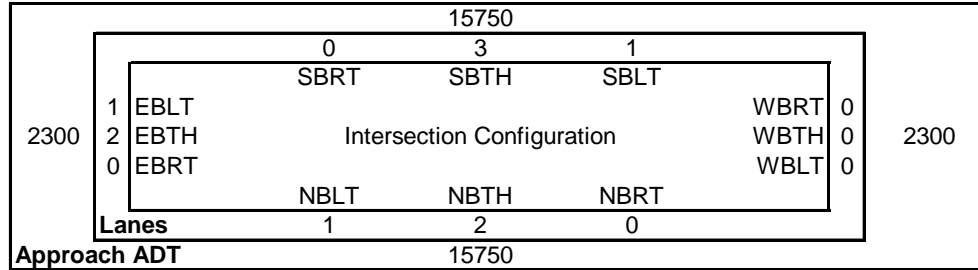

Implementation/Installation Details

Controller
 Conflict Monitor

Crash Data Summary

Observed/Emperical Data				Target Crash Analysis				
Months of Data (Before/After)	Approach ADT (Before)	Approach ADT (After)	Observed Before Crashes	Observed After Crashes	Left-turn Crashes (Before)	Left-turn Crashes (After)	Approach LT Crashes (Before)	Approach LT Crashes (After)
72/8	17500	18000	11.5	10.5	1.8	0.0	1.3	0.0

Comments:
 Skewed angle approach on minor street.

Alexandria

Duke Street/N. Pickett/Cameron Mills

Intersection ID: 128
 State: VA

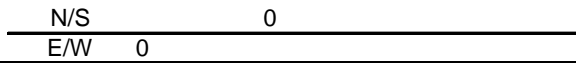

Left-Turn Details

Previous Left-turn Control: 0
 Major Street Speed Limit: 0
 Date Converted to FYA PPLT: 1/0/1900
 FYA Display: 0
 Cost Estimation: \$0

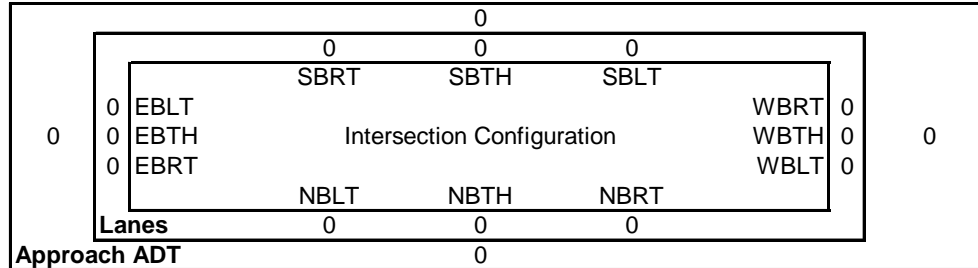

Implementation/Installation Details

Controller
 Conflict Monitor

Crash Data Summary

Observed/Emperical Data				Target Crash Analysis				
Months of Data (Before/After)	Approach ADT (Before)	Approach ADT (After)	Observed Before Crashes	Observed After Crashes	Left-turn Crashes (Before)	Left-turn Crashes (After)	Approach LT Crashes (Before)	Approach LT Crashes (After)
36/24	0	0	4.0	3.0	1.0	2.0	0.0	2.0

Comments:
 ADT unavailable.

Alexandria King/N Beauregard

Intersection ID: 129
 State: VA

N/S Beauregard Street/Walter Reed Drive
 E/W King Street (VA 7)

Left-Turn Details

Previous Left-turn Control: PPLT
 Major Street Speed Limit: 35
 Date Converted to FYA PPLT: Comparison
 FYA Display: Comparison
 Cost Estimation: \$0

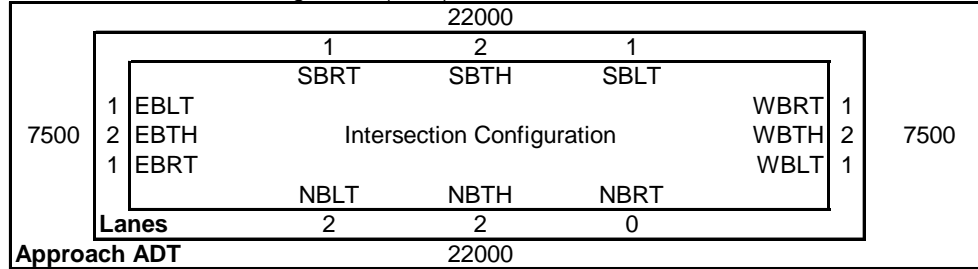

Implementation/Installation Details

Controller
 Conflict Monitor

Crash Data Summary

Observed/Emperical Data				Target Crash Analysis				
Months of Data (Before/After)	Approach ADT (Before)	Approach ADT (After)	Observed Before Crashes	Observed After Crashes	Left-turn Crashes (Before)	Left-turn Crashes (After)	Approach LT Crashes (Before)	Approach LT Crashes (After)
36/24	0	0	8.0	6.0	2.0	1.0	0.7	0.5

Comments:
 ADT unavailable.

Alexandria N Beauregard/N Morgan

Intersection ID: 130
 State: VA

N/S Beauregard Street
 E/W Morgon Street

Left-Turn Details

Previous Left-turn Control: PPLT
 Major Street Speed Limit: 35
 Date Converted to FYA PPLT: Comparison
 FYA Display: Comparison
 Cost Estimation: \$0

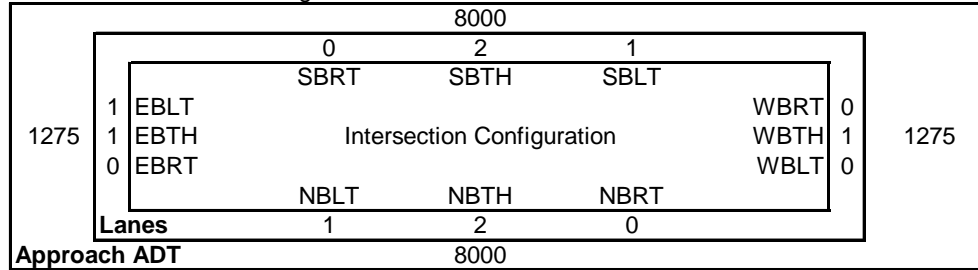

Implementation/Installation Details

Controller
 Conflict Monitor

Crash Data Summary

Observed/Emperical Data				Target Crash Analysis				
Months of Data (Before/After)	Approach ADT (Before)	Approach ADT (After)	Observed Before Crashes	Observed After Crashes	Left-turn Crashes (Before)	Left-turn Crashes (After)	Approach LT Crashes (Before)	Approach LT Crashes (After)
36/24	0	0	2.7	4.5	1.0	1.5	0.3	1.5

Comments:
 ADT unavailable.

Alexandria N Beauregard/Sanger

Intersection ID: 131
 State: VA

N/S Beauregard Street
 E/W Sanger Avenue

Left-Turn Details

Previous Left-turn Control: PPLT
 Major Street Speed Limit: 35
 Date Converted to FYA PPLT: Comparison
 FYA Display: Comparison
 Cost Estimation: \$0

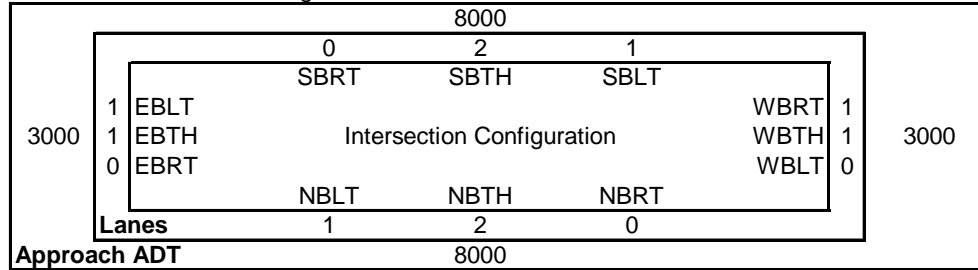

Implementation/Installation Details

Controller
 Conflict Monitor

Crash Data Summary

Observed/Emperical Data				Target Crash Analysis				
Months of Data (Before/After)	Approach ADT (Before)	Approach ADT (After)	Observed Before Crashes	Observed After Crashes	Left-turn Crashes (Before)	Left-turn Crashes (After)	Approach LT Crashes (Before)	Approach LT Crashes (After)
36/24	16000	0	5.0	7.5	0.7	3.0	0.7	3.0

Comments:
 ADT unavailable for after period.

Alexandria Seminary/Howard

Intersection ID: 132
 State: VA

N/S Howard Street
 E/W Seminary Road

Left-Turn Details

Previous Left-turn Control: PPLT
 Major Street Speed Limit: 0
 Date Converted to FYA PPLT: Comparison
 FYA Display: Comparison
 Cost Estimation: \$0

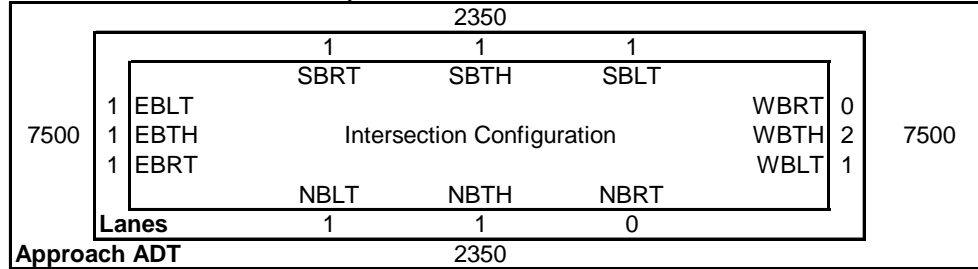

Implementation/Installation Details

Controller
 Conflict Monitor

Crash Data Summary

Observed/Emperical Data				Target Crash Analysis				
Months of Data (Before/After)	Approach ADT (Before)	Approach ADT (After)	Observed Before Crashes	Observed After Crashes	Left-turn Crashes (Before)	Left-turn Crashes (After)	Approach LT Crashes (Before)	Approach LT Crashes (After)
36/24	15000	15000	4.3	3.5	1.7	0.0	0.3	0.0

Comments:

ODOT OR 99W/Baker Creek

Intersection ID: 138
 State: OR

N/S Baker Creek Road
 E/W OR 99W

Left-Turn Details

Previous Left-turn Control: PPLT
 Major Street Speed Limit: 35
 Date Converted to FYA PPLT: Comparison
 FYA Display: Doghouse
 Cost Estimation: \$0

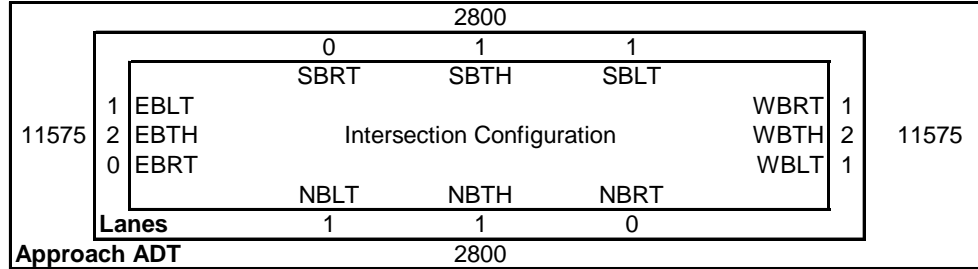

Implementation/Installation Details

Controller
 Conflict Monitor

Crash Data Summary

Observed/Emperical Data				Target Crash Analysis				
Months of Data (Before/After)	Approach ADT (Before)	Approach ADT (After)	Observed Before Crashes	Observed After Crashes	Left-turn Crashes (Before)	Left-turn Crashes (After)	Approach LT Crashes (Before)	Approach LT Crashes (After)
36/48	23150	0	8.3	6.3	1.3	1.8	1.3	1.0

Comments:
 ADT unavailable for after period.

ODOT OR 99E/Young Street

Intersection ID: 143
 State: OR

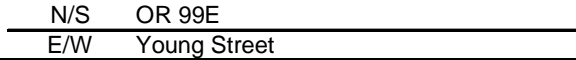

Left-Turn Details

Previous Left-turn Control: PPLT
 Major Street Speed Limit: 35
 Date Converted to FYA PPLT: Comparison
 FYA Display: Doghouse
 Cost Estimation: \$0

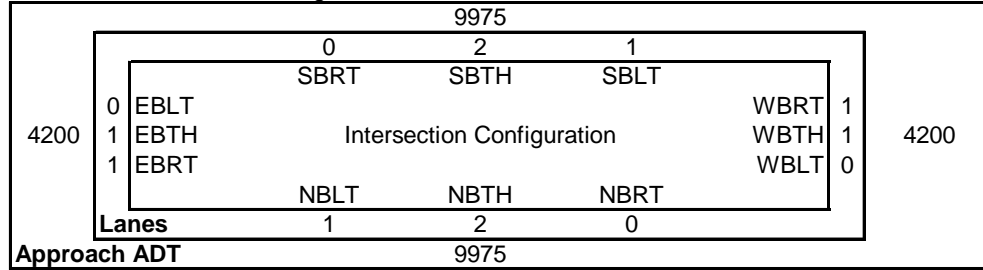

Implementation/Installation Details

Controller
 Conflict Monitor

Crash Data Summary

Observed/Emperical Data				Target Crash Analysis				
Months of Data (Before/After)	Approach ADT (Before)	Approach ADT (After)	Observed Before Crashes	Observed After Crashes	Left-turn Crashes (Before)	Left-turn Crashes (After)	Approach LT Crashes (Before)	Approach LT Crashes (After)
24/54	19950	0	9.0	3.1	6.0	3.6	4.5	0.2

Comments:
 ADT unavailable for after period.

ODOT OR 99E/"D" Street

Intersection ID: 144
 State: OR

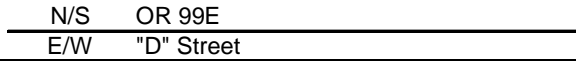

Left-Turn Details

Previous Left-turn Control: PPLT
 Major Street Speed Limit: 40
 Date Converted to FYA PPLT: Comparison
 FYA Display: Control
 Cost Estimation: \$0

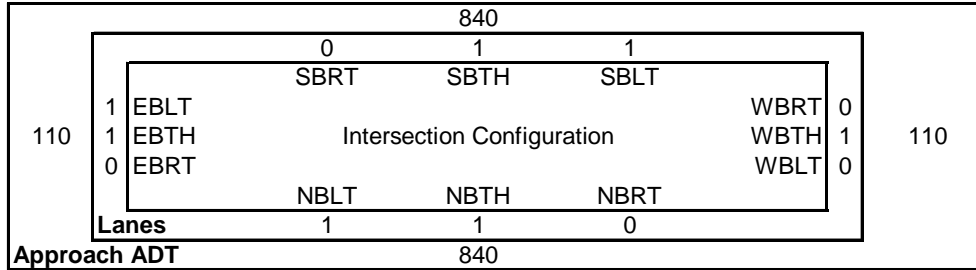

Implementation/Installation Details

Controller
 Conflict Monitor

Crash Data Summary

Observed/Emperical Data				Target Crash Analysis				
Months of Data (Before/After)	Approach ADT (Before)	Approach ADT (After)	Observed Before Crashes	Observed After Crashes	Left-turn Crashes (Before)	Left-turn Crashes (After)	Approach LT Crashes (Before)	Approach LT Crashes (After)
36/48	16800	0	3.3	7.5	0.0	2.3	0.0	0.8

Comments:
 ADT unavailable for after period.

Snohomish Co. 164th St SW & 6th Ave W

Intersection ID: 145 N/S 6th Avenue W./E. Shore Drive
 State: WA E/W 164th Street SE

Left-Turn Details

Previous Left-turn Control: Major PPLT, Minor Perm
 Major Street Speed Limit: 35
 Date Converted to FYA PPLT: Comparison
 FYA Display: 0
 Cost Estimation: \$0

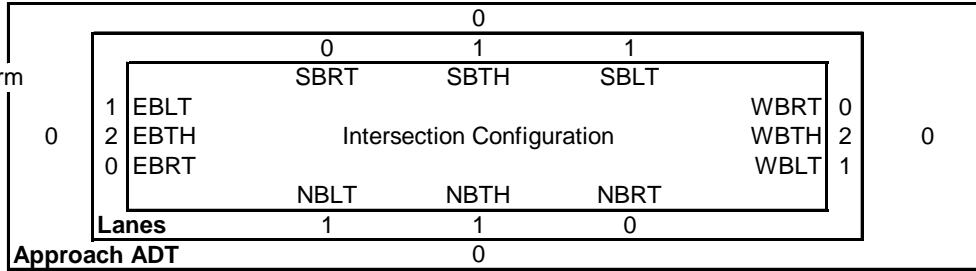

Implementation/Installation Details

Controller
 Conflict Monitor

Crash Data Summary

Observed/Emperical Data					Target Crash Analysis			
Months of Data (Before/After)	Approach ADT (Before)	Approach ADT (After)	Observed Before Crashes	Observed After Crashes	Left-turn Crashes (Before)	Left-turn Crashes (After)	Approach LT Crashes (Before)	Approach LT Crashes (After)
60/12	38725	0	8.6	10.0	1.8	4.0	1.2	2.0

Comments:
 ADT unavailable for after period.

Snohomish Co. 165th Street SE/1st Avenue SE
 Intersection ID: 146
 State: WA
Left-Turn Details
 Previous Left-turn Control: 0
 Major Street Speed Limit: 0
 Date Converted to FYA PPLT: Comparison
 FYA Display: 0
 Cost Estimation: \$0

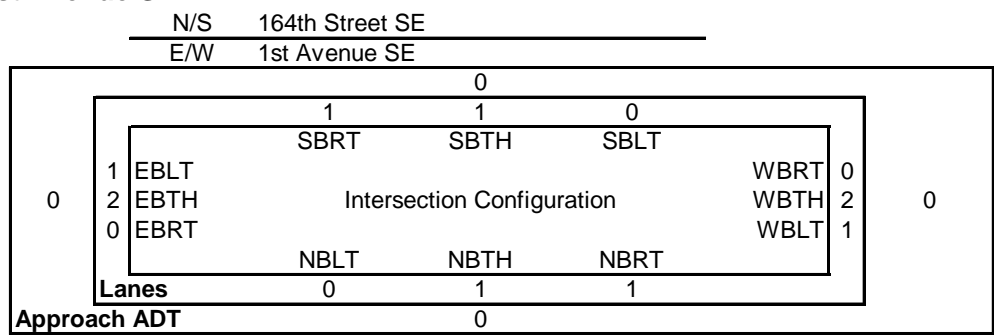

Implementation/Installation Details
 Controller
 Conflict Monitor

Crash Data Summary

Observed/Emperical Data					Target Crash Analysis			
Months of Data (Before/After)	Approach ADT (Before)	Approach ADT (After)	Observed Before Crashes	Observed After Crashes	Left-turn Crashes (Before)	Left-turn Crashes (After)	Approach LT Crashes (Before)	Approach LT Crashes (After)
60/12	0	0	4.6	3.0	0.6	0.0	0.6	0.0

Comments:
 ADT unavailable.

Snohomish Co. 165th Street SW/13th Avenue W
 Intersection ID: 147
 State: WA
Left-Turn Details
 Previous Left-turn Control: 0
 Major Street Speed Limit: 0
 Date Converted to FYA PPLT: 1/0/1900
 FYA Display: 0
 Cost Estimation: \$0

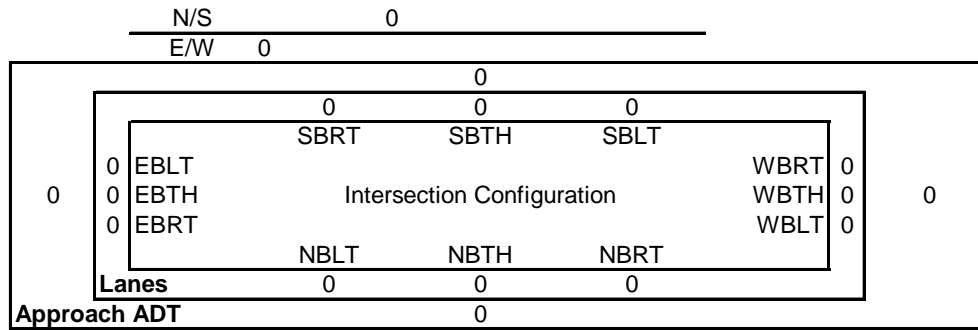

Implementation/Installation Details
 Controller
 Conflict Monitor

Crash Data Summary

Observed/Emperical Data				Target Crash Analysis				
Months of Data (Before/After)	Approach ADT (Before)	Approach ADT (After)	Observed Before Crashes	Observed After Crashes	Left-turn Crashes (Before)	Left-turn Crashes (After)	Approach LT Crashes (Before)	Approach LT Crashes (After)
60/12	0	0	6.6	8.0	1.0	1.0	0.4	0.0

Comments:
 ADT unavailable.

Snohomish Co. 164th St SW & 6th Ave W

Intersection ID: 148 N/S 6th Avenue W./E. Shore Drive
 State: WA E/W 164th Street SE

Left-Turn Details

Previous Left-turn Control: Major PPLT, Minor Perm
 Major Street Speed Limit: 35
 Date Converted to FYA PPLT: Comparison
 FYA Display: 0
 Cost Estimation: \$0

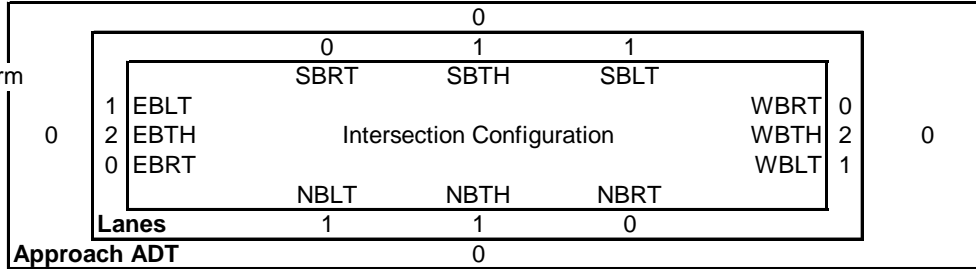

Implementation/Installation Details

Controller
 Conflict Monitor

Crash Data Summary

Observed/Emperical Data				Target Crash Analysis				
Months of Data (Before/After)	Approach ADT (Before)	Approach ADT (After)	Observed Before Crashes	Observed After Crashes	Left-turn Crashes (Before)	Left-turn Crashes (After)	Approach LT Crashes (Before)	Approach LT Crashes (After)
60/17	38725	0	7.6	13.4	1.6	4.2	1.0	2.8

Comments:
 ADT unavailable for after period.

APPENDIX F – TABLE SUMMARY OF GROUPED EVALUATION DATA

Table F1 – Group Evaluation Data for Sites Converted from PPLT Phasing to PPLT with the FYA Display.

ID	Intersection Name	Location/ Jurisdiction	FYA Conversion Date	Number of Approaches with FYA PPLT	Number of Opposing Through Lanes	FYA ADT (Before)	FYA ADT (After)	Months of Crash Data (Before/ After)	Total Crashes Before FYA (Annual)	Total Crashes After FYA (Annual)	Difference in Total Crashes	Percent Reduction	Target Crashes Before FYA (Annual)	Target Crashes After FYA (Annual)	Difference in Target Crashes	Target Crashes Percent Reduction
43	US 117/Big K	New Hanover Co., NC	11/1/2005	2	3	60361	65916	60/12	11.4	8.0	-3.4	-30%	9.2	-	-	-
45	125th Avenue/ Longhorn Drive	Beaverton, OR	5/2/2002	2	1	9327	9554	36/55	1.3	0.4	-0.9	-67%	1.0	-	-	-
49	Allen Boulevard/ Menlo Drive	Beaverton, OR	4/25/2002	2	2	27259	28093	36/48	4.0	3.0	-1.0	-25%	2.0	1.0	-1.0	-50%
50	Allen Boulevard/ Wilson Avenue	Beaverton, OR	4/23/2002	1	2	13394	13943	36/48	2.7	1.5	-1.2	-44%	0.3	-	-	-
67	Pine(Biddle Road)/ Hamrick (EB)	Jackson Co., OR	5/1/2001	1	2	11733	13923	60/60	9.4	3.6	-5.8	-62%	0.8	-	-	-
81	ORE 10/ White Pine	ODOT_Beaverton, OR	5/3/2005	1	2	28700	28900	48/18	2.3	0.7	-1.6	-70%	0.8	-	-	-
85	ORE 99E/ Hardcastle Street (N/S)	ODOT_Woodburn, OR	6/14/2001	2	2	78000	83400	24/54	5.5	3.1	-2.4	-43%	1.0	0.2	-0.8	-78%
86	ORE 99E/Lincoln Street (N/S)	ODOT_Woodburn, OR	6/14/2001	2	2	78000	83400	24/48	2.5	1.0	-1.5	-60%	1.0	-	-	-
92	Duke Street/4600/ Fox Chase	Alexandria, VA	11/16/2004	2	3	31000	31000	36/24	6.3	4.0	-2.3	-37%	1.3	1.0	-0.3	-25%
93	Duke Street/ Jordan Street	Alexandria, VA	9/21/2004	1	3	14500	14500	36/24	5.7	3.0	-2.7	-47%	0.0	-	-	-
98	Mullen Road/ Ruddell Road	Lacey, WA	3/9/2005	1	2	9100	8103	36/24	8.0	5.0	-3.0	-38%	-	-	-	-
100	128th St. SW & 5th Place West (E/W)	Snohomish Co., WA	5/11/2005	2	2.5	18590	20110	60/17	8.4	9.2	0.8	-	4.2	2.8	-1.4	-33%
101	164th St SE & 9th Ave/Main/Mill (E/W)	Snohomish Co., WA	1/28/2005	2	2	36341	37890	22/21	18.5	15.4	-3.1	-17%	-	-	-	-

Table F2 – Group Evaluation Data for Sites Converted from Protected-only Left-turn Phasing to PPLT with the FYA Display.

ID	Intersection Name	Location/ Jurisdiction	FYA Conversion Date	Number of Approaches with FYA PPLT	Number of Opposing Through Lanes	FYA ADT (Before)	FYA ADT (After)	Months of Crash Data (Before/ After)	Total Crashes Before FYA (Annual)	Total Crashes After FYA (Annual)	Difference in Total Crashes	Percent Reduction	Target Crashes Before FYA (Annual)	Target Crashes After FYA (Annual)	Difference in Target Crashes	Target Crashes Percent Reduction
1	Magnolia Avenue/ Park Avenue	El Cajon, CA	6/29/2005	2	1.5	24478	26349	36/12	3.3	7.0	3.7	-	0.3	2.0	1.7	-
4	Orangethorpe Ave./ Lemon St.	Fullerton, CA	3/1/2005	2	2	18066	18738	60/19	3.2	6.9	3.7	-	-	2.5	-	-
28	Brighton Rd./ Brighton H.S. Entrance	Livingston Co., MI	7/11/2005	1	1	19995	17324	60/24	2.0	1.5	-0.5	-25%	-	-	-	-
29	Old US-23/Spencer Rd E (7.909)	Livingston Co., MI	7/27/2005	1	1	7797	8250	60/24	8.2	6.0	-2.2	-27%	-	-	-	-
30	Old US-23/Spencer Rd W (NB US-23)	Livingston Co., MI	7/27/2005	1	1	7829	8675	60/24	11.8	7.5	-4.3	-36%	-	-	-	-
58	Hall Boulevard/ Nimbus Avenue	Beaverton, OR	5/12/2005	2	2	25111	25971	60/18	6.4	4.7	-1.7	-27%	0.6	0.7	0.1	-
66	Main/ Lozier Lane	Jackson Co., OR	4/18/2002	4	1	19842	21181	60/48	2.6	2.8	0.2	-	0.0	1.5	1.5	-
69	Pine/NB I-5 Ramp (EB Only)	Jackson Co., OR	10/20/2004	1	2	10915	10915	72/24	1.0	4.0	3.0	-	-	-	-	-
70	Pine/SB I-5 Ramp (WB Only)	Jackson Co., OR	10/19/2004	1	2	11365	11365	72/24	0.8	3.0	2.2	-	-	-	-	-
72	Table Rock/ Antelope	Jackson Co., OR	7/13/2001	4	1	25749	28369	60/60	1.0	2.0	1.0	-	-	1.0	-	-
73	Table Rock/ Biddle Road (EB/WB)	Jackson Co., OR	7/9/2001	2	2	13727	14499	60/48	3.4	4.8	1.4	-	0.2	0.8	0.6	-
75	ORE 10/107th	ODOT_Beaverton, OR	5/10/2005	2	2	31800	32000	60/19	3.2	7.6	4.4	-	0.0	3.2	3.2	-
76	ORE 10/110th	ODOT_Beaverton, OR	4/13/2005	1	2	32100	32300	60/20	3.4	6.0	2.6	-	0.0	3.0	3.0	-
78	ORE 10/ 91st	ODOT_Beaverton, OR	5/10/2005	2	2	28700	28900	60/19	3.8	7.0	3.2	-	0.0	2.0	2.0	-
79	ORE 10/ Laurelwood	ODOT_Beaverton, OR	5/11/2005	2	2	27750	27950	60/19	13.9	5.0	-8.9	-64%	2.5	3.0	0.5	-
80	ORE 10/ Western	ODOT_Beaverton, OR	4/13/2005	1	2	32350	32600	60/19	3.2	3.2	0.0	-1%	0.4	1.3	0.9	-
103	Airport Road/ Admiralty Way	Snohomish Co., WA	10/19/2005	2	2	17100	19130	60/12	9.0	11.0	2.0	-	0.2	-	-	-
104	Airport Road/ Gibson Road	Snohomish Co., WA	11/2/2005	2	2	17550	18230	60/12	6.4	10.0	3.6	-	0.6	3.0	2.4	-

Table F3 – Group Evaluation Data for Sites Converted from Permitted Left-turn Phasing to PPLT with the FYA Display.

ID	Intersection Name	Location/ Jurisdiction	FYA Conversion Date	Number of Approaches with FYA PPLT	Number of Opposing Through Lanes	FYA ADT (Before)	FYA ADT (After)	Months of Crash Data (Before/ After)	Total Crashes Before FYA (Annual)	Total Crashes After FYA (Annual)	Difference in Total Crashes	Percent Reduction	Target Crashes Before FYA (Annual)	Target Crashes After FYA (Annual)	Difference in Target Crashes	Target Crashes Percent Reduction
7	Table Mesa Drive/ Tantra Drive	Boulder, CO	5/19/2004	2	2	26447	26600	36/27	10.7	3.6	-7.1	-67%	0.7	-	-	-
53	Beaverton-Hillsdale Highway/ Griffith Drive	Beaverton, OR	11/12/2004	2	1	5000	5100	60/24	5.6	6.5	0.9	-	0.2	-	-	-
82	N. Hayden Island Drive/ Center Street	ODOT_Portland, OR	8/11/2005	1	2	5350	0	60/17	3.2	1.4	-1.8	-56%	0.0	-	-	-
87	US 26/ORE 211	ODOT_Sandy, OR	8/24/2005	1	1	1600	0	60/16	1.4	1.5	0.1	-	0.2	-	-	-

APPENDIX G –TABLE SUMMARY OF SITES NOT INCLUDED IN GROUP EVALUATION

Table G1 – Group Evaluation Data for Excluded Sites Converted from PPLT Phasing to PPLT with the FYA Display.

ID	Intersection Name	Location/ Jurisdiction	FYA Conversion Date	Number of Approaches with FYA PPLT	Number of Opposing Through Lanes	FYA ADT (Before)	FYA ADT (After)	Months of Crash Data (Before/ After)	Total Crashes Before FYA (Annual)	Total Crashes After FYA (Annual)	Difference in Total Crashes	Percent Reduction	Target Crashes Before FYA (Annual)	Target Crashes After FYA (Annual)	Difference in Target Crashes	Target Crashes Percent Reduction
6	30th Street/ Walnut Street	Boulder, CO	6/27/2004	4	1.5	38280	38972	36/25	-	-	-	-	8.3	10.1	1.7	-
8	Broward Boulevard/ NW 69th Avenue	Broward Co., FL	6/5/2002	1	3	22083	22800	36/36	9.0	12.3	3.3	-	3.0	0.7	-2.3	-78%
11	I-84 Business/ Lowes/ Mall Main Entrance	ITD_Nampa, ID	6/22/2004	4	2	21242	25491	48/24	2.5	5.0	2.5	-	0.5	0.5	0.0	-
12	I-84 Business/ Shopko/ Kmart	ITD_Nampa, ID	6/22/2004	2	2	21242	25491	48/24	3.8	5.0	1.3	-	-	-	-	-
42	SR 2911/Wake Medical Center	NCDOT_Wake Co., NC	2/1/2005	2	2	25630	26649	60/13	8.4	5.5	-2.9	-34%	3.2	-	-	-
68	Pine Street/ Peninger	Jackson Co., OR	5/21/2002	4	1.5	26374	31482	60/49	2.2	3.2	1.0	-	-	-	-	-
96	Columbia Center/Deschutes	Kennewick, WA	10/27/2005	4	1.5	32868	36829	48/19	6.8	11.4	4.6	-	1.8	6.9	5.2	-
97	Columbia Center/Grandridge Boulevard	Kennewick, WA	11/17/2005	2	1.5	23606	26395	48/18	8.0	8.0	0.0	-	2.0	0.7	-1.3	-67%

Table G2 – Group Evaluation Data for Excluded Sites Converted from Protected-only Left-turn Phasing to PPLT with the FYA Display.

ID	Intersection Name	Location/ Jurisdiction	FYA Conversion Date	Number of Approaches with FYA PPLT	Number of Opposing Through Lanes	FYA ADT (Before)	FYA ADT (After)	Months of Crash Data (Before/ After)	Total Crashes Before FYA (Annual)	Total Crashes After FYA (Annual)	Difference in Total Crashes	Percent Reduction	Target Crashes Before FYA (Annual)	Target Crashes After FYA (Annual)	Difference in Target Crashes	Target Crashes Percent Reduction
2	Chapman Ave./ Commonwealth Ave.	Fullerton, CA	2/1/2005	2	2	35820	36670	60/19	6.6	1.3	-5.3	-81%	0.6	0.6	0.0	-
3	Euclid St./ Valencia Dr.	Fullerton, CA	4/1/2005	4	2	42000	43248	60/18	7.2	9.3	2.1	-	0.8	4.7	3.9	-
5	State College Blvd./ Dorothy Lane	Fullerton, CA	2/1/2006	2	3	33000	33000	60/6	3.4	10.0	6.6	-	-	-	-	-
31	Whitmore Lake Rd./ Lee Rd.	Livingston Co., MI	11/3/2004	3	1	9059	14720	60/20	10.8	9.6	-1.2	-11%	-	-	-	-
32	Whitmore Lake Rd./ Old US-23/ Grand River Ave.	Livingston Co., MI	11/8/2004	4	1.5	40836	40754	70/24	20.9	30.5	9.6	-	-	-	-	-
74	Table Rock/Vilas	Jackson Co., OR	5/14/2001	4	1	28751	32390	60/48	2.2	2.5	0.3	-	0.2	0.3	0.1	-
99	128th St SW/ 8th Street	Snohomish Co., WA	11/16/2005	2	2.5	18040	19760	60/10	6.4	12.0	5.6	-	0.8	7.2	6.4	-
105	E. 19th St./ Converse Ave.	Cheyenne, WY	10/16/2005	1	2	5730	6002	60/14.5	7.0	5.8	-1.2	-17%	-	-	-	-
106	Pershing Blvd./ Converse Ave.	Cheyenne, WY	10/16/2005	3	2	25510	26628	60/14.5	11.0	6.6	-4.4	-40%	-	-	-	-

Table G3 – Group Evaluation Data for Excluded Sites Converted from Permitted Left-turn Phasing to PPLT with the FYA Display.

ID	Intersection Name	Location/ Jurisdiction	FYA Conversion Date	Number of Approaches with FYA PPLT	Number of Opposing Through Lanes	FYA ADT (Before)	FYA ADT (After)	Months of Crash Data (Before/ After)	Total Crashes Before FYA (Annual)	Total Crashes After FYA (Annual)	Difference in Total Crashes	Percent Reduction	Target Crashes Before FYA (Annual)	Target Crashes After FYA (Annual)	Difference in Target Crashes	Target Crashes Percent Reduction
94	10th Avenue/ Kellogg Street	Kennewick, WA	Permitted	3/17/2005	3-section	4	1.5	17145	17797	48/26	3.5	6.5	3.0	-	2.3	1.8